

FEATURES



Non-isolated 1/32 Brick DC/DC Converter

Input voltage: 9~53Vdc

Single output: 5~30Vdc

Output power: 100W

T31SN24005NNFA, 1/32 Brick, 9~53V input, single output, non-isolated DC/DC converters, are the latest offering from a world leader in power systems technology and manufacturing — Delta Electronics, Inc. This product family provides up to 100 watts of power or 4.5A of output current. With creative design technology and optimization of component placement, these converters possess outstanding electrical and thermal performance, as well as extremely high reliability under highly stressful operating conditions. Peak efficiency of the 27Vin/24Vout/4.5A module is up to 98.0%.

Electrical

- ♦ High efficiency: 98.0% @ 27Vin/24Vo 4.5A
- ♦ Industry standard 1/32nd brick form factor
- ♦ Fixed frequency operation
- ♦ Thermal limit, Input UVLO
- ♦ Output OCP Hiccup mode
- ♦ Output voltage trim range: 5V~30V
- ♦ Output Remote sense
- ♦ Monotonic startup into normal
- ♦ No minimum load requirement
- ♦ Working altitude to 5000m

Mechanical

Size: Open frame (through hole)

- ♦ 19.1mm x 23.4 mm x 9.6 mm
(0.75 in. x 0.92 in. x 0.38 in.)

Size: Open frame (surface mount)

- ♦ 19.1mm x 23.4 mm x 10.1 mm
(0.75 in. x 0.92 in. x 0.40 in.)

Size: Potting (standard case)

- ♦ 23.1mm x 27.6 mm x 12.7 mm
(0.91 in. x 1.09 in. x 0.50 in.)

Size: Potting (flanged case)

- ♦ 23.1mm x 38.9 mm x 12.7 mm
(0.91 in. x 1.53 in. x 0.50 in.)

Soldering Methods

- ♦ Wave soldering
- ♦ Hand soldering
- ♦ Reflow soldering(MSL of rating 3)

Safety & Certificate

- ♦ IEC/EN/UL/CSA 62368-1,2nd edition
- ♦ IEC/EN/UL/CSA 60950-1,2nd edition+A2
- ♦ ISO 9001, TL 9000, ISO 14001, QS 9000,
- ♦ OHSAS18001 certified manufacturing facility

OPTIONS

- ♦ Negative or Positive Remote On/Off
- ♦ Power Good
- ♦ Through hole pins or SMD pins
- ♦ Open frame or Potting
- ♦ Potting with Standard case or Flanged case

PARAMETER	NOTES and CONDITIONS	T31SN24005			
		Min.	Typ.	Max.	Units
ABSOLUTE MAXIMUM RATINGS					
Input Voltage					Vdc
Continuous		-0.25		55	Vdc
Transient (100ms)	NA				Vdc
Operating Ambient Temperature		-40		85	°C
Storage Temperature		-55		125	°C
Input/Output Isolation Voltage	None	/		/	Vdc
INPUT CHARACTERISTICS					
Operating Input Voltage	Vin>Vo	9		53	Vdc
Input Under-Voltage Lockout					
Turn-On Voltage Threshold			8		Vdc
Turn-Off Voltage Threshold			7	9	Vdc
Lockout Hysteresis Voltage			1		Vdc
Maximum Input Current	Vin= 28V ,Vo=24 ; Io=Io,max			10	A
No-Load Input Current	Vin=48V, Vo=24V, Io=0A		46		mA
Off Converter Input Current	Vin=48V, Vo=24V, Io=0A		0.6		mA
Inrush Current (I ² t)				1	A ² s
Input Reflected-Ripple Current	24Vin,Vo=15V,P-P thru 33µH inductor, 5Hz to 20MHz		2.5		mA
Input Voltage Ripple Rejection	120 Hz		50		dB
OUTPUT CHARACTERISTICS					
Output Voltage Set Point	Vin=48V, Vo=15V, Io=Io,max, Tc=25°C	-2		+2	%
Output Regulation					
Load Regulation	Io=Io, min to Io, max		0.7		%Vo,set
Line Regulation	Vin=9V to 53V		0.2		%Vo,set
Temperature Regulation	Tc=-40°C to 85°C	-1		+1	%Vo,set
Total Output Voltage Range	Over sample load, line and temperature	-4		+4	%Vo,set
Output Voltage Ripple and Noise	5Hz to 20MHz bandwidth				
Peak-to-Peak	Vin=48V, Vo=24V, Full Load, 0.1µF ceramic, 22µF ceramic,20M BW		70		mV
RMS	Vin=48V, Vo=24V, Full Load, 0.1µF ceramic, 22µF ceramic		24		mV
Operating Output Current Range	Observe Maximum power limit	0		4.5	A
Output Over Current Protection(hiccup mode)			9		A
DYNAMIC CHARACTERISTICS					
Output Voltage Current Transient	48Vin,Vo=24V, 0.1µF ceramic, 22µF ceramic load cap, 1 A/µs				
Positive Step Change in Output Current	75% Io,max to 25% Io,max		350		mV
Negative Step Change in Output Current	25% Io,max to 75% Io,max		350		mV
Settling Time (within 1% nominal Vout)			30		µs
Turn-On Delay and Rise Time					
Start-Up Delay Time From Input Voltage	On/Off=On, from Vin=Turn-On Threshold to Vo=10% Vo,nom		4		mS
Start-Up Delay Time From On/Off Control	Vin=Vin,nom, from On/Off=On to Vo=10% Vo,nom		4		mS
Output Voltage Rise Time	Vo=10% to 90% Vo,nom		7		mS
Output Capacitance (note1)	Full load; 5% overshoot of Vout at startup	22		1200	µF
EFFICIENCY					
100% Load	Vin=24V,Vo=15V,Io=Io,max		96.8		%
100% Load	Vin=24V,Vo=18V,Io=Io,max		97.5		%
100% Load	Vin=36V,Vo=18V,Io=Io,max		96.5		%
100% Load	Vin=36V,Vo=24V,Io=Io,max		97.2		%
100% Load	Vin=48V,Vo=18V,Io=Io,max		95.2		%
100% Load	Vin=48V,Vo=28V,Io=Io,max		96.5		%
FEATURE CHARACTERISTICS					
Switching Frequency			300		KHz
On/Off Control, Negative Remote On/Off logic					
Logic Low (Module On)	Von/off	0		0.5	V
Logic High (Module Off)	Von/off	3.1		13.2	V
On/Off Control, Positive Remote On/Off logic					
Logic Low (Module Off)	Von/off	0		0.5	V
Logic High (Module On)	Von/off	3.1		13.2	V
On/Off Current (for both remote On/Off logic)	Ion/off at Von/off=0.0V		0.4		mA
Output Voltage Adjustment Range		5		30	V
Output Voltage Remote Sense Range		0		+5	%Vo,nom
GENERAL SPECIFICATIONS					
MTBF	Io=80% of Io, max; Ta=40°C, airflow rate=300LFM		14		Mhours
Weight	Open frame		8		grams
Weight	Potting		20		grams

Note: For applications with higher output capacitive load, please contact Delta.

T_A=25°C

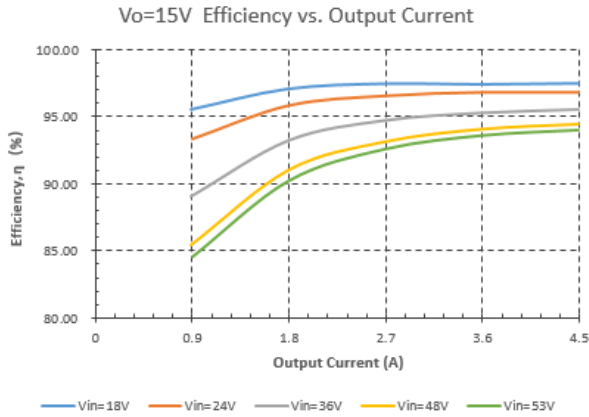

Figure 1: Efficiency vs. Output Current (Vo=15V)

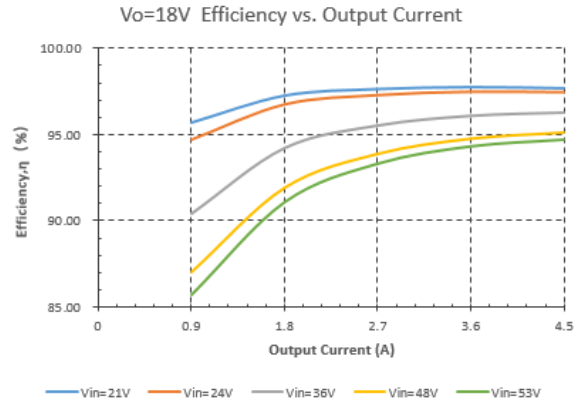

Figure 2: Efficiency vs. Output Current (Vo=18V)

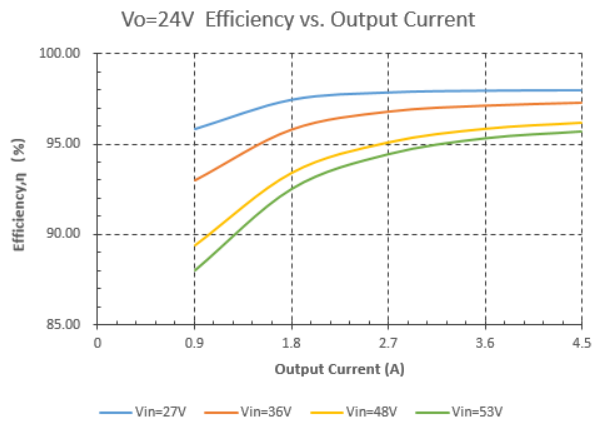

Figure 3: Efficiency vs. Output Current (Vo=24V)

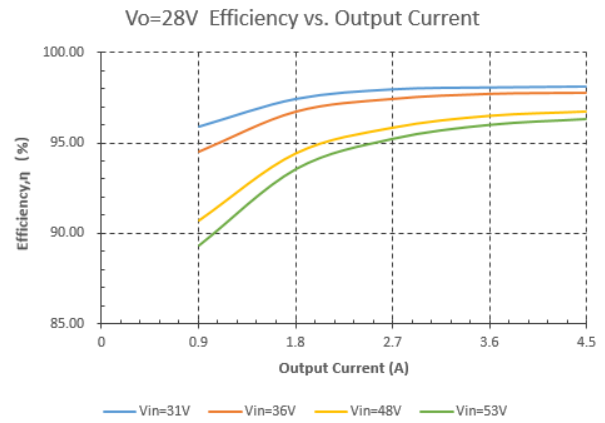

Figure 4: Efficiency vs. Output Current (Vo=28V)

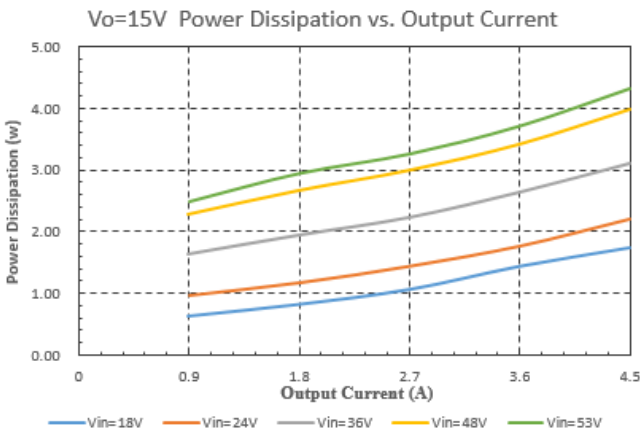

Figure 5: Power Dissipation vs. Output Current(Vo=15V)

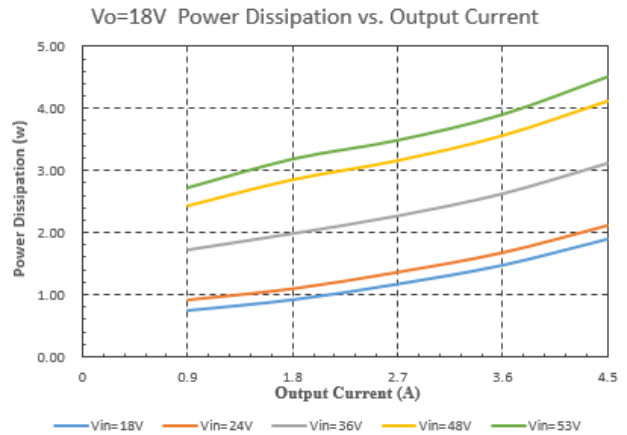

Figure 6: Power Dissipation vs. Output Current(Vo=18V)

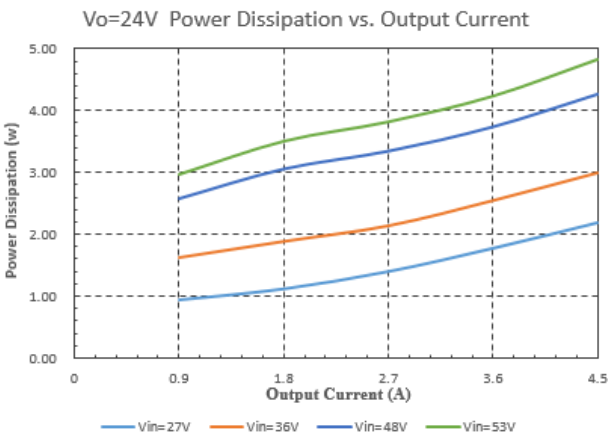

Figure 7: Power Dissipation vs. Output Current(Vo=24V)

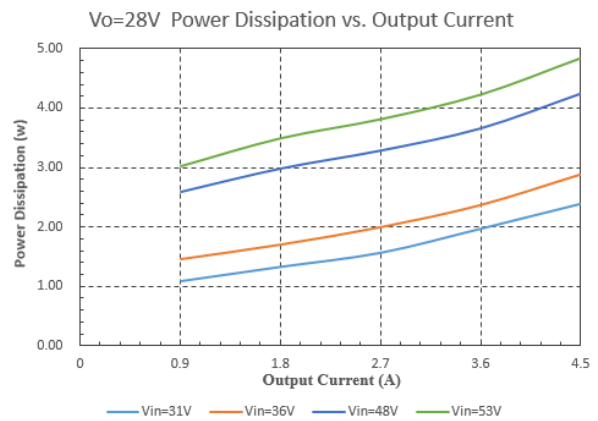

Figure 8: Power Dissipation vs. Output Current(Vo=28V)

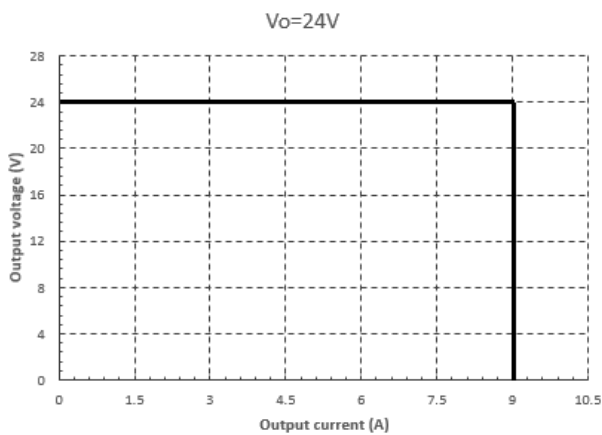

Figure 9: Output Voltage vs. Output current showing typical current limit curves and converter shutdown points.

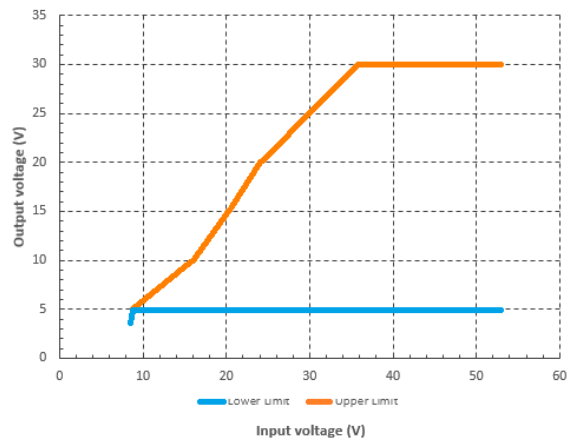

Figure 10: Output Voltage versus Input Voltage Operating Range

TA=25°C, Vin=48Vdc, Vo=18V

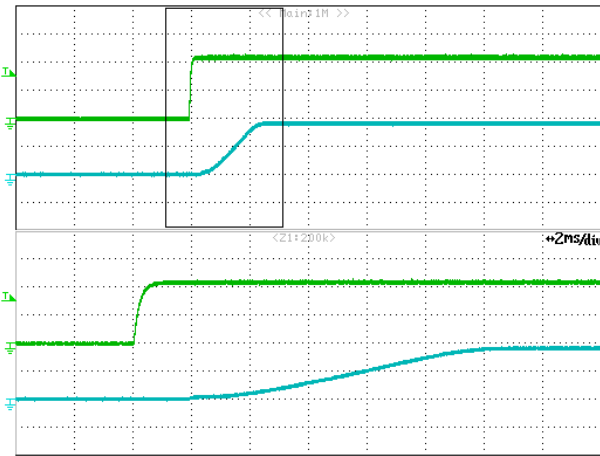

Figure 11: Remote On/Off Start-up at open load

Time: 10ms/div.

Vremote On/Off signal(top trace): 2V/div;

Vout (bottom trace): 10V/div.

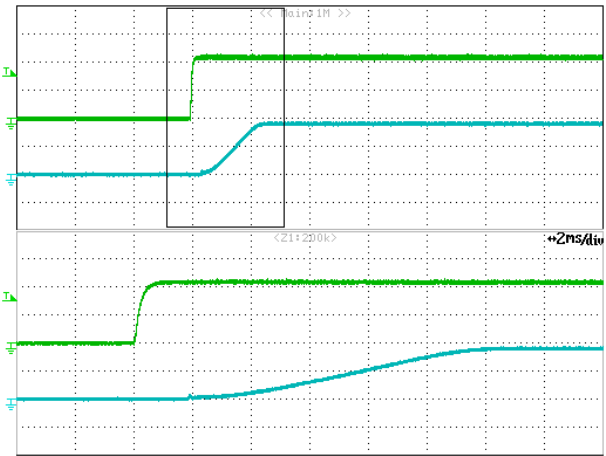

Figure 12: Remote On/Off Start-up at full load

Time: 10ms/div.

Vremote On/Off signal(top trace): 2V/div;

Vout (bottom trace): 10V/div.

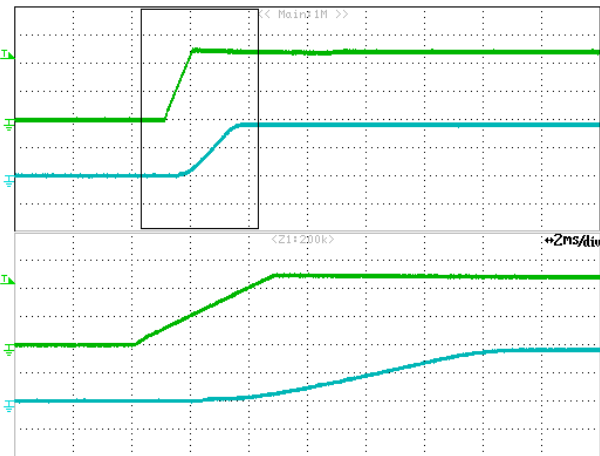

Figure 13: Input Voltage Start-up at open load

Time: 10ms/div.

Vin (top trace): 20V/div;

Vout (bottom trace): 10V/div.

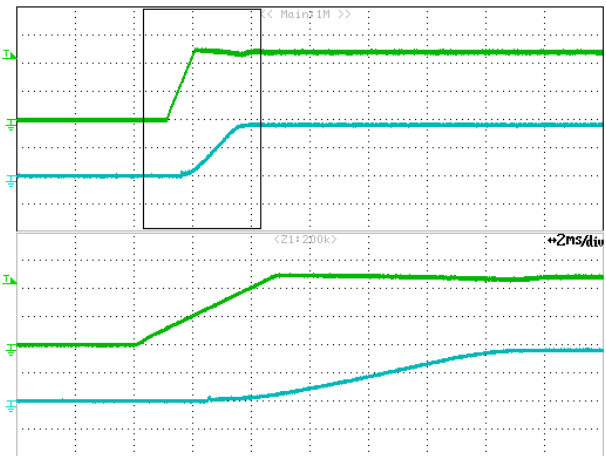

Figure 14: Input Voltage Start-up at full load

Time: 10ms/div.

Vin (top trace): 20V/div;

Vout (bottom trace): 10V/div.

TA=25°C, Vin=48Vdc, Vo=18V

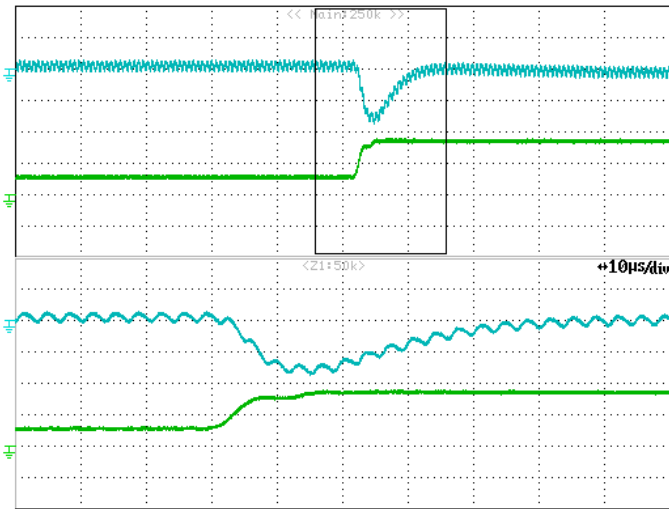

Figure 15: Transient Response

(1A/μs step change in load from 25% to 75% of $I_{o, max}$)

V_{out} (top trace): 0.2 V/div, 50us/div;

I_{out} (bottom trace): 2A/div.

Load cap: 22μF ceramic capacitor and 1μF ceramic capacitor.

Scope measurement should be made using a BNC cable (length shorter than 20 inches). Position the load between 51 mm to 76 mm (2 inches to 3 inches) from the module

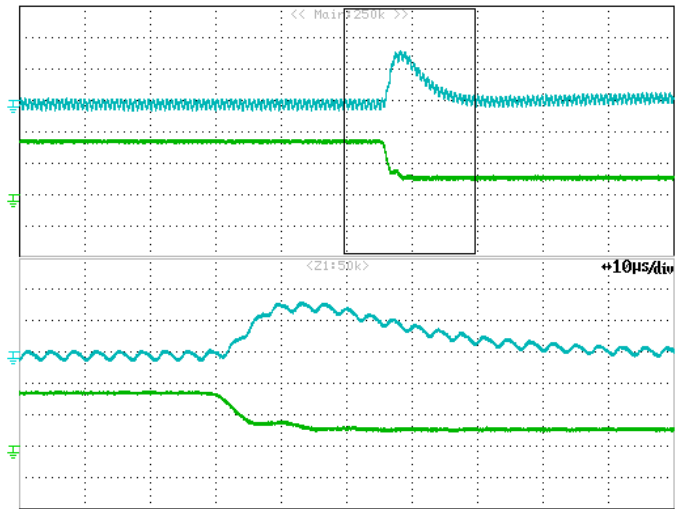

Figure 16: Transient Response

(1A/μs step change in load from 75% to 25% of $I_{o, max}$)

V_{out} (top trace): 0.2V/div, 50us/div;

I_{out} (bottom trace): 2A/div.

Load cap: 22μF ceramic capacitor and 1μF ceramic capacitor.

Scope measurement should be made using a BNC cable (length shorter than 20 inches). Position the load between 51 mm to 76 mm (2 inches to 3 inches) from the module

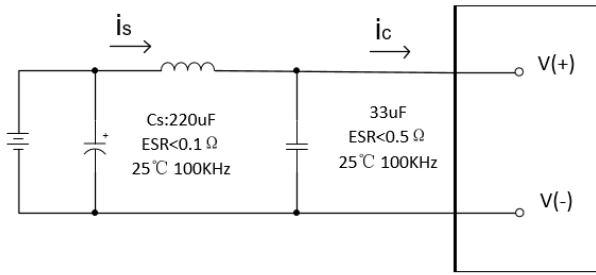

Figure 17: Test Setup Diagram for Input Ripple Current
 Note: Measured input reflected-ripple current with a simulated source Inductance (L_{TEST}) of $12\mu H$. Capacitor C_s offset possible battery impedance. Measure current as shown above.

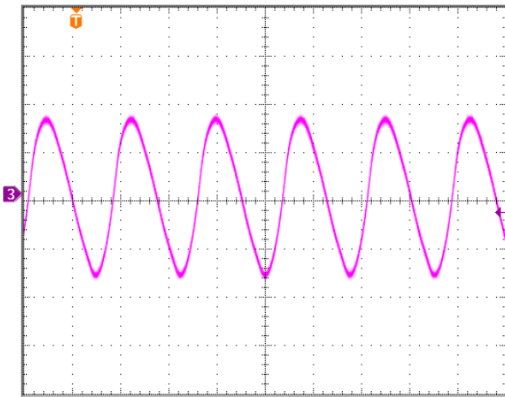

Figure 18: Input Terminal Ripple Current, i_c , at max output current, 48Vdc input voltage and 15Vdc output voltage with $12\mu H$ source impedance and $33\mu F$ electrolytic capacitor (500 mA/div, 2us/div).

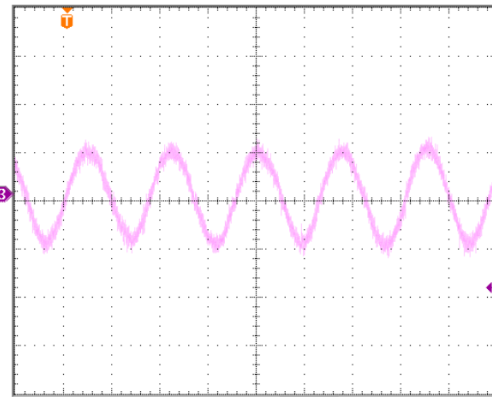

Figure 19: Input Reflected Ripple Current, i_s , through a $12\mu H$ source inductor at 48Vdc input voltage, 15Vdc output voltage and max load current (100mA/div, 2us/div).

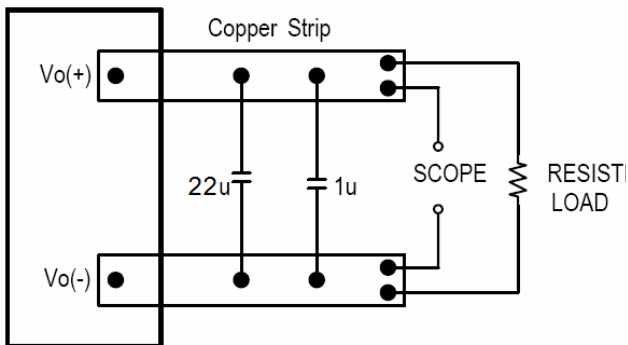

Figure 20: Test Setup for Output Voltage Noise and Ripple

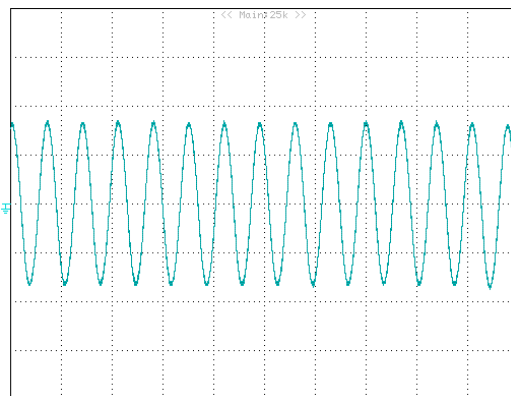

Figure 21: Output Voltage Ripple and Noise at 48Vdc input voltage, 24Vdc output voltage and max load current (20 mV/div, 5us/div)
 Load cap: $1\mu F$ ceramic capacitor and $22\mu F$ ceramic capacitor.
 Bandwidth: 20MHz

Input Source Impedance

The impedance of the input source connecting to the DC/DC power modules will interact with the modules and affect the stability. A low ac-impedance input source is recommended. If the source inductance is more than a few μH , we advise 33 μF -100 μF electrolytic capacitor (ESR < 0.7 Ω at 100kHz) mounted close to the input of the module to improve the stability.

Safety Considerations

The power module must be installed in compliance with the spacing and separation requirements of the end-user's safety agency standard, i.e., IEC 62368-1, UL60950-1, CSA C22.2 NO. 60950-1 2nd and IEC 60950-1 2nd: 2005 and EN 60950-1 2nd: 2006+A11+A1: 2010, if the system in which the power module is to be used must meet safety agency requirements.

This power module is not internally fused. To achieve optimum safety and system protection, an input line fuse is highly recommended. The safety agencies require a fast-acting fuse with 20A maximum rating to be installed in the ungrounded lead. A lower rated fuse can be used based on the maximum inrush transient energy and maximum input current.

Soldering and Cleaning Considerations

Post solder cleaning is usually the final board assembly process before the board or system undergoes electrical testing. Inadequate cleaning and/or drying may lower the reliability of a power module and severely affect the finished circuit board assembly test. Adequate cleaning and/or drying is especially important for un-encapsulated and/or open frame type power modules. For assistance on appropriate soldering and cleaning procedures, please contact Delta's technical support team.

Over-Current Protection

The modules include an internal output over-current protection circuit, which will endure current limiting for an unlimited duration during output overload. If the output current exceeds the OCP set point, the modules will shut down (hiccup mode).

The modules will try to restart after shutdown. If the overload condition still exists, the module will shut down again. This restart trial will continue until the overload condition is corrected.

Remote On/Off

The remote On/Off feature on the module can be either negative or positive logic depend on the part number options on the last page. Remote On/Off can be controlled by an external switch between the On/Off terminal and the Vi(-) terminal. The switch can be an open collector or open drain. The maximum allowable leakage current of the switch is 10uA. The switch must be capable of maintaining a low signal Vo/off<0.25V while sinking 1mA.

- ❖ **For Negative logic version**, turns the module on during an external switch is on, it will be off during an external switch is off and floating. If the remote on/off feature is not used, please short the On/Off pin to Vi(-).
- ❖ **For Positive logic version**, turns the modules off during an external switch is on, it will be on during an external switch is off and the on/off pin is floating. If the remote On/Off feature is not used, please leave the On/Off pin to floating.

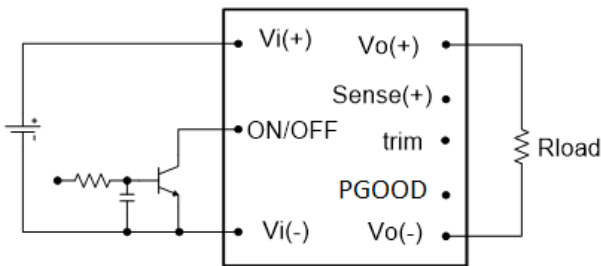

Figure 22: Remote On/Off Implementation

Remote Sense

Remote sense compensates for voltage drops in the power distribution path by sensing the voltage at the load point. The output voltage sense range defines the maximum voltage allowed between the sense and the output power, and it is shown on the electrical data page. If remote sense feature is not used, the sense pin should be connected to the Vo(+) pin.

The output voltage at the Vo(+) can be increased by either remote sense or trim, the maximum voltage increase allowed is the larger of the remote sense range or the output voltage adjustment range; it is not the sum of both. As the output voltage increases with the maximum output current due to the use of remote sense, please ensure the output power of the module does not exceed the maximum rated power.

Power Good

The power module provides an optional open-drain PGOOD signal which indicates if the output voltage is being regulated. When the module is power on, but output voltage is more than +/-5 from the expect voltage set point due to input under voltage, over temperature, over load, or out of control, the power good signal will be pulling low. A 10 kΩ pull-up resistor is recommended to 3.3V source. If the power good feature is not used, this pin should be left open.

Thermal Limit

The modules include an internal thermal shutdown function, which provides protection from thermal damage. If the junction temperature of the controller IC reaches the over-temperature threshold, the module will shut down.

The modules will try to restart after shutdown. If the over-temperature condition still exists, the module will shut down again. The module restarts repeat until the temperature of the device has fallen below the thermal reset level(135°C typ).

Output Voltage Adjustment (TRIM)

To decrease the output voltage set point, connect an external resistor between the TRIM pin and the Vo(-) pin. The TRIM pin should be left open if this feature is not used.

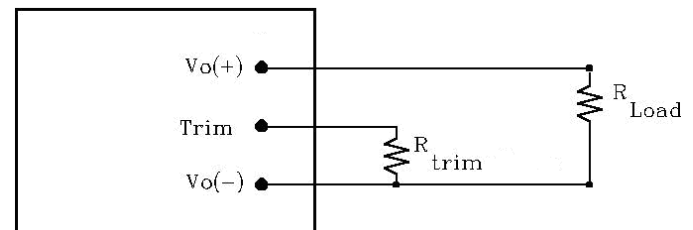

Figure 23: Circuit Configuration for Trim (decrease output voltage)

If the external resistor is connected between the TRIM and Vo(-) pins, the output voltage can be set (Fig.26). To adjust the output voltage, the trim resistor is defined as:

$$R_{trim} = \left[\frac{V_{ref} * F}{V_o - 2.59} - 0.511 \right] (\text{k}\Omega)$$

The values of Vref is 0.6 , and F is 36.5.

Ex. When Vo=15V,

$$R_{trim} = \left[\frac{0.6 * 36.5}{15 - 2.59} - 0.511 \right] (\text{k}\Omega) = 1.25(\text{k}\Omega)$$

Vo	Rtrim
15V	1.25K/F
18V	0.91K/F
24V	0.51K/F
28V	0.35K/F
30V	0.287K/F

Thermal Testing Setup (Airflow Cooling)

Thermal management is an important part of the system design. To ensure proper, reliable operation, sufficient cooling of the power module is needed over the entire temperature range of the module. Convection cooling is usually the dominant mode of heat transfer.

Hence, the choice of equipment to characterize the thermal performance of the power module is a wind tunnel.

Delta's DC/DC power modules are characterized in heated vertical wind tunnels that simulate the thermal environments encountered in most electronics equipment. This type of equipment commonly uses vertically mounted circuit cards in cabinet racks in which the power modules are mounted.

The following figure shows the wind tunnel characterization setup. The power module is mounted on a 120mmX180mm, 70µm (2Oz), 4 layers test PWB and is vertically positioned within the wind tunnel. The space between the neighboring PWB and the top of the power module is constantly kept at 6.35mm (0.25").

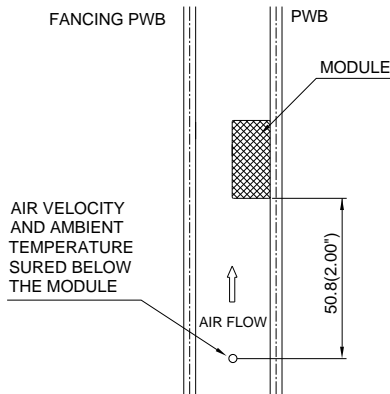

Note: Wind Tunnel Test Setup Figure Dimensions are in millimeters and (Inches)

Figure 24: Wind Tunnel Test Setup

Thermal Derating

Heat can be removed by increasing airflow over the module. To enhance system reliability, the power module should always be operated below the maximum operating temperature. If the temperature exceeds the maximum module temperature, reliability of the unit may be affected.

Thermal Curves (Open Frame)

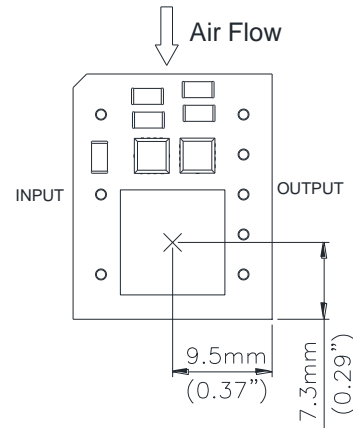

Figure 25: * Hot spot temperature measured point. The allowed maximum hot spot temperature is defined at 120°C.

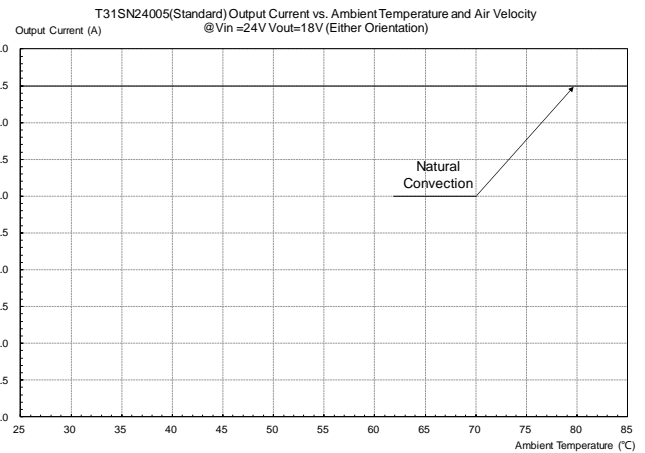

Figure 26: Output current vs. ambient temperature and air velocity @ Vin=24V, Vout=18V (Either Orientation, Open Frame)

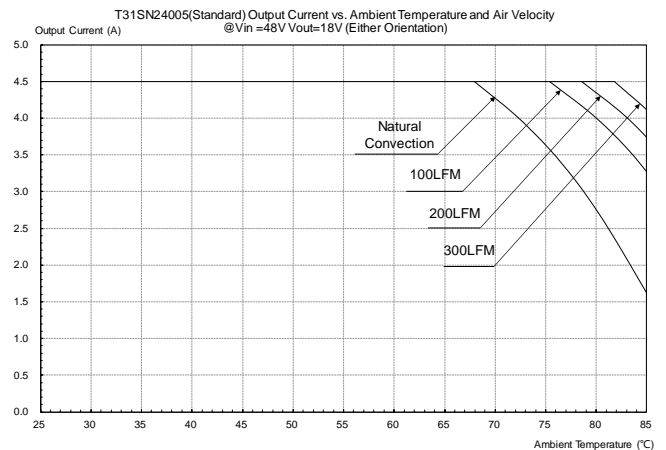

Figure 27: Output current vs. ambient temperature and air velocity @ Vin=48V, Vout=18V (Either Orientation, Open Frame)

Thermal Curves (Open Frame)

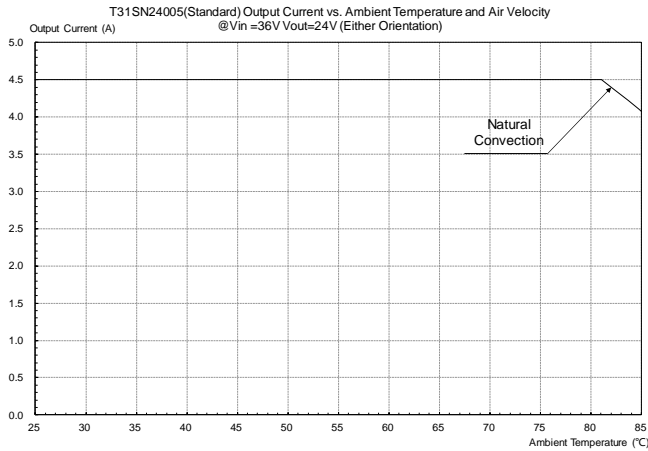

Figure 28: Output current vs. ambient temperature and air velocity @V_{in}=36V, V_{out}=24V (Either Orientation, Open Frame)

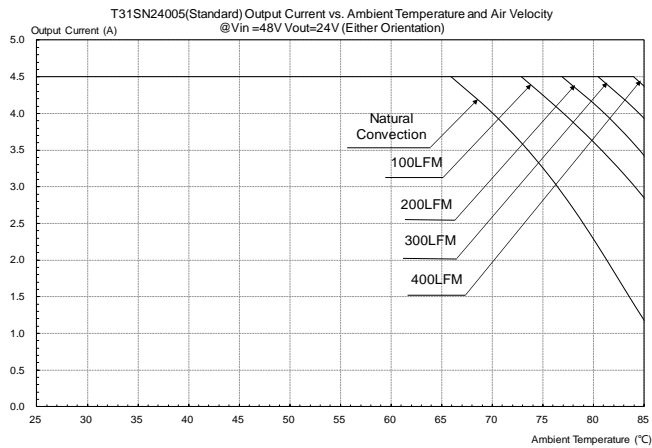

Figure 29: Output current vs. ambient temperature and air velocity @V_{in}=48V, V_{out}=24V (Either Orientation, Open Frame)

Thermal Curves (Potting)

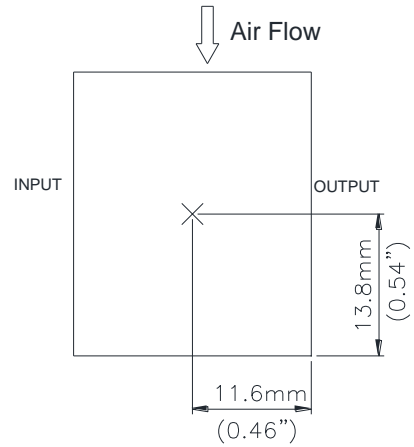

Figure 30: * Hot spot temperature measured point. The allowed maximum hot spot temperature is defined at 115°C.

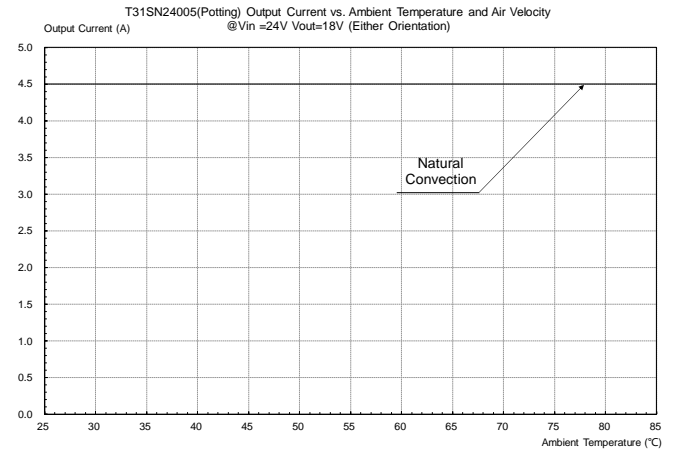

Figure 31: Output current vs. ambient temperature and air velocity @V_{in}=24V, V_{out}=18V (Either Orientation, Potting)

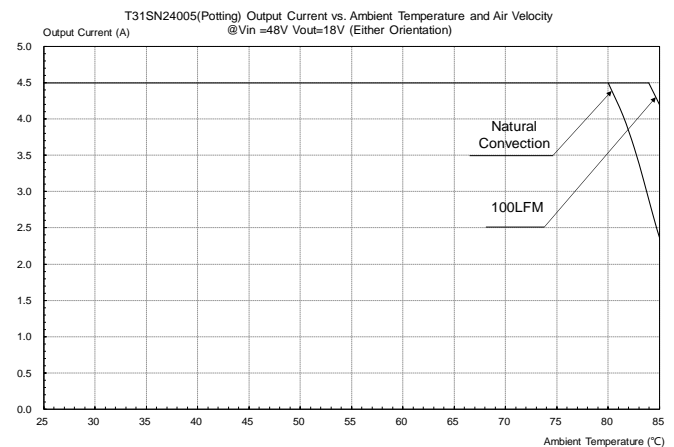

Figure 32: Output current vs. ambient temperature and air velocity @V_{in}=48V, V_{out}=18V (Either Orientation, Potting)

Thermal Curves (Potting)

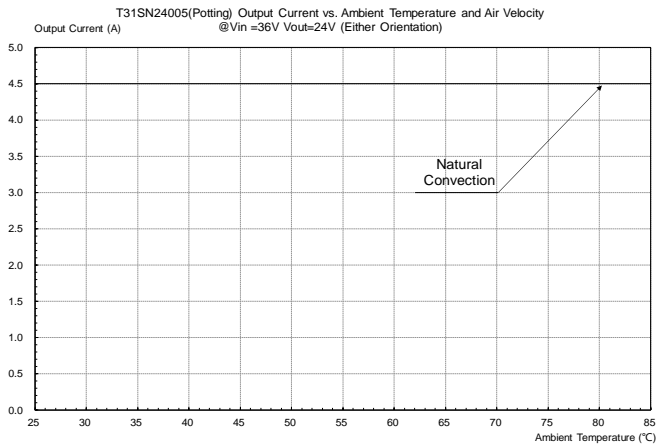

Figure 33: Output current vs. ambient temperature and air velocity @ $V_{in}=36V$, $V_{out}=24V$ (Either Orientation, Potting)

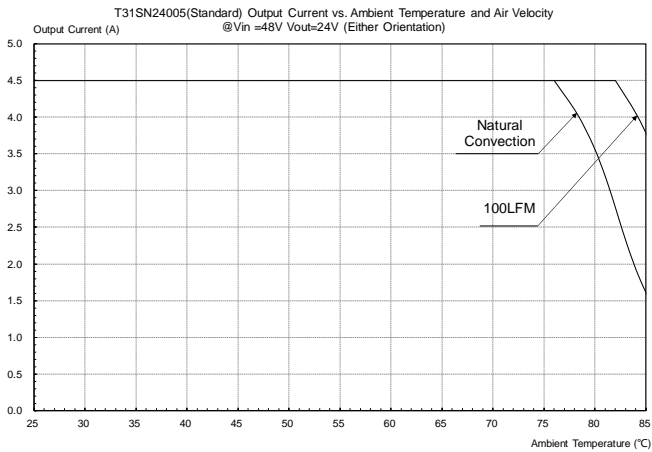

Figure 34: Output current vs. ambient temperature and air velocity @ $V_{in}=48V$, $V_{out}=24V$ (Either Orientation, Potting)

Thermal Testing Setup (Cold Plate Cooling)

The following figure shows cold plate cooling test setup. The power module is mounted on a 120mmX180mm, 70 μ m (2Oz), 4 layers test PWB and attach to a cold plate with thermal interface material (TIM).

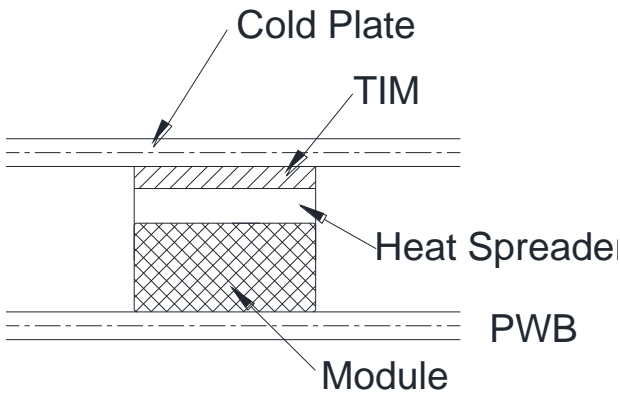

Figure 35: Cold Plate Cooling Test Setup

Thermal Curves (Potting, Attach to Cold Plate)

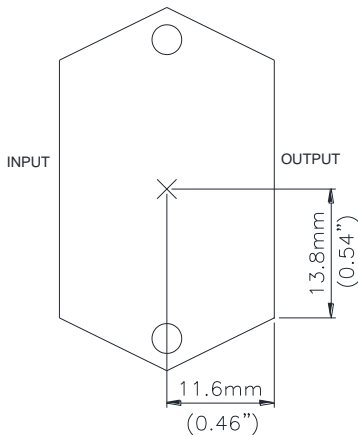

Figure 36: * Hot spot on metal case temperature measured point. The allowed maximum hot spot temperature is defined at 110°C.

Thermal Curves (Potting, Attach to Cold Plate)

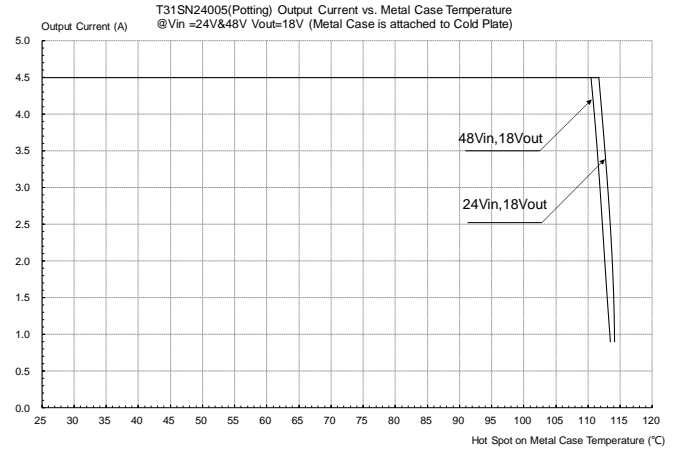

Figure 37: Output Current vs. Hot Spot on Metal Case Temperature @ $V_{in}=24V$ & $48V$, $V_{out}=18V$ (Potting, Attach to Cold Plate)

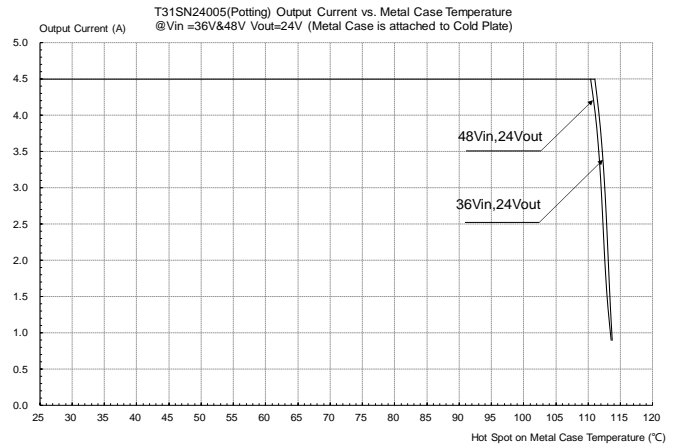
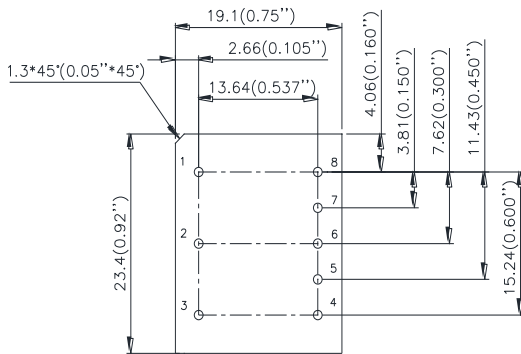
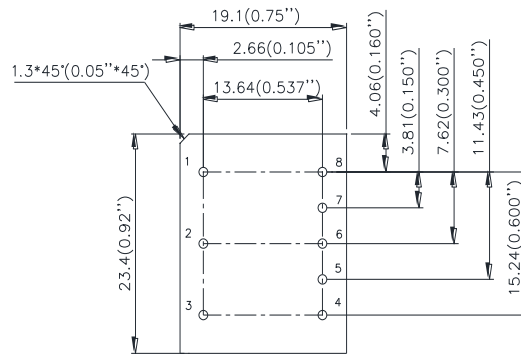
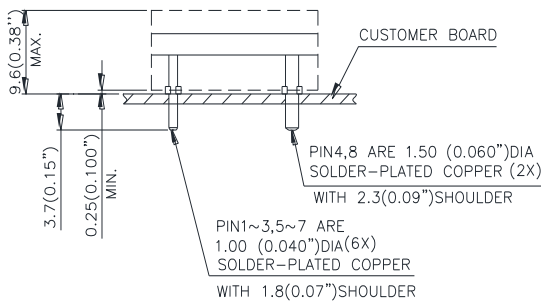
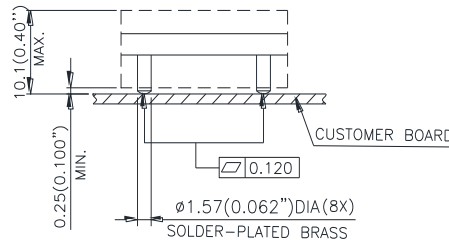

Figure 38: Output Current vs. Hot Spot on Metal Case Temperature @ $V_{in}=36V$ & $48V$, $V_{out}=24V$ (Potting, Attach to Cold Plate)

Mechanical Drawing (Open Frame Through Hole And Surface Mount)
Through hole

TOP VIEW
Surface mount

TOP VIEW

SIDE VIEW

SIDE VIEW

Pin#	Function
1	VIN(+)
2	ON/OFF
3	VIN(-)
4	VOUT(-)
5	PG(OPTIONAL)
6	Trim
7	SENSE(+)
8	VOUT(+)

NOTES:

DIMENSIONS ARE IN MILLIMETERS AND (INCHES)

TOLERANCES: X.Xmm±0.5mm(X.XX in.±0.02 in.)

X.XXmm±0.25mm(X.XXX in.±0.010 in.)

Note: All pins are copper alloy with matte Tin (Pb free) plated over Nickel under plating.

Mechanical Drawing (Through Hole Potting Module)

Standard case

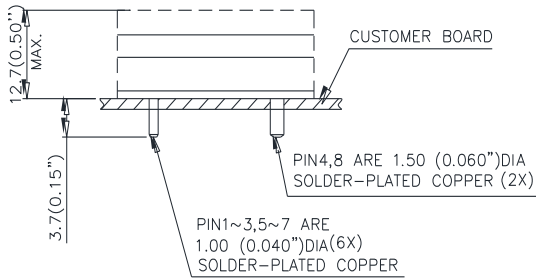

Flanged case

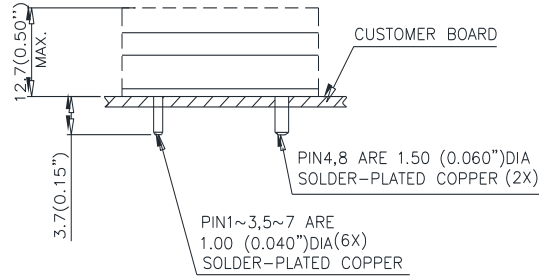

SIDE VIEW

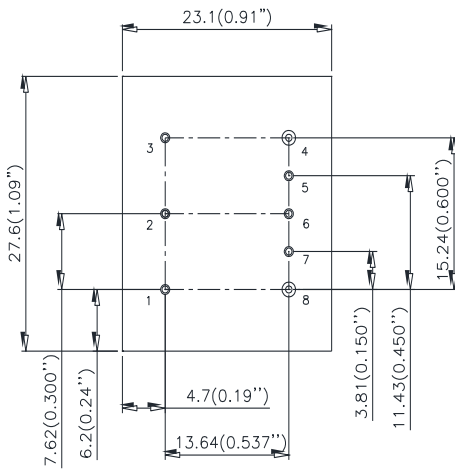

BOTTOM VIEW

SIDE VIEW

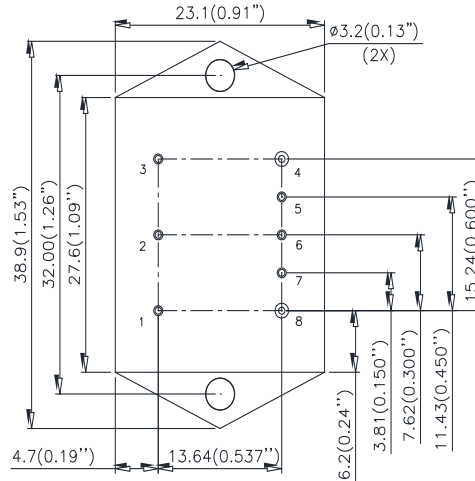

BOTTOM VIEW

Pin#	Function
1	VIN(+)
2	ON/OFF
3	VIN(-)
4	VOUT(-)
5	PG(OPTIONAL)
6	Trim
7	SENSE(+)
8	VOUT(+)

NOTES:

DIMENSIONS ARE IN MILLIMETERS AND (INCHES)

TOLERANCES: X.Xmm±0.5mm(X.XX in.±0.02 in.)

X.XXmm±0.25mm(X.XXX in.±0.010 in.)

Note: All pins are copper alloy with matte Tin (Pb free) plated over Nickel under plating.

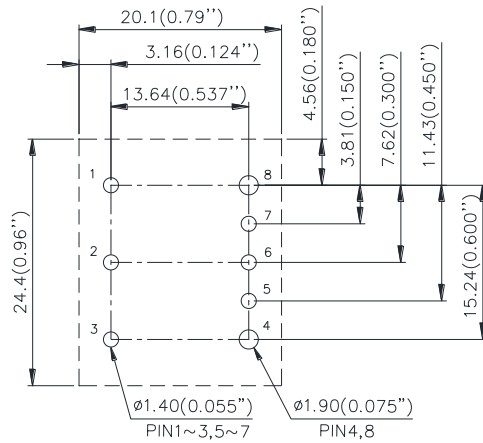
Recommended Pad Layout (Open Frame Through-Hole Module)
RECOMENDED P.W.B. PAD LAYOUT

Pin#	Function
1	VIN(+)
2	ON/OFF
3	VIN(-)
4	VOUT(-)
5	PG(OPTIONAL)
6	Trim
7	SENSE(+)
8	VOUT(+)

NOTES:

DIMENSIONS ARE IN MILLIMETERS AND (INCHES)

 TOLERANCES: X.Xmm \pm 0.5mm(X.XX in. \pm 0.02 in.)

 X.XXmm \pm 0.25mm(X.XXX in. \pm 0.010 in.)

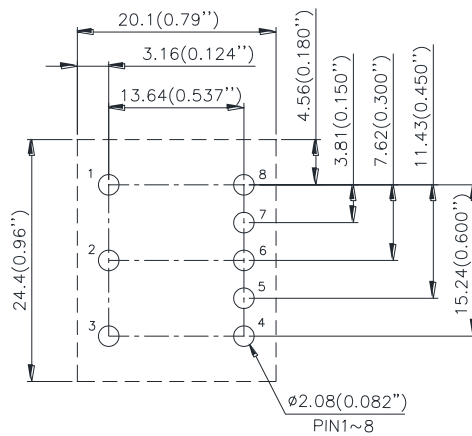
Recommended Pad Layout (Open Frame Surface Mount Module)
RECOMENDED P.W.B. PAD LAYOUT

Pin#	Function
1	VIN(+)
2	ON/OFF
3	VIN(-)
4	VOUT(-)
5	PG(OPTIONAL)
6	Trim
7	SENSE(+)
8	VOUT(+)

NOTES:

DIMENSIONS ARE IN MILLIMETERS AND (INCHES)

 TOLERANCES: X.Xmm \pm 0.5mm(X.XX in. \pm 0.02 in.)

 X.XXmm \pm 0.25mm(X.XXX in. \pm 0.010 in.)

Recommended Pad Layout (Through Hole Potting Module)

Standard case

RECOMENDED P.W.B. PAD LAYOUT

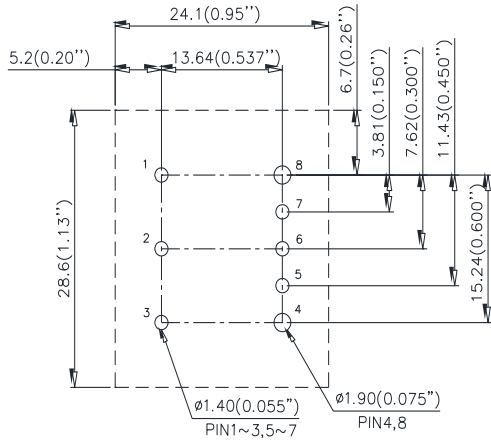

Flanged case

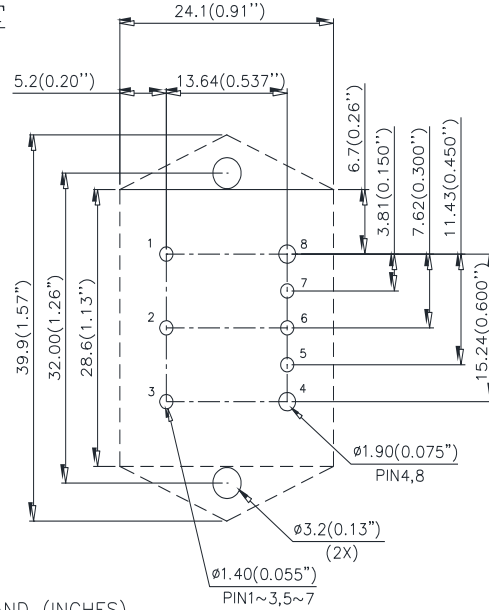

Pin#	Function
1	VIN(+)
2	ON/OFF
3	VIN(-)
4	VOUT(-)
5	PG(OPTIONAL)
6	Trim
7	SENSE(+)
8	VOUT(+)

NOTES:
 DIMENSIONS ARE IN MILLIMETERS AND (INCHES)
 TOLERANCES: X.Xmm±0.5mm(X.XX in.±0.02 in.)
 X.XXmm±0.25mm(X.XXX in.±0.010 in.)

Soldering Method

Generally, as the most common mass soldering method for the solder attachment, wave soldering is used for through-hole power modules and reflow soldering is used for surface-mount ones. Delta recommended soldering methods and process parameters are provided in this document for solder attachment of power modules onto system board. SAC305 is the suggested lead-free solder alloy for all soldering methods. The soldering temperature profile presented in this document is based on SAC305 solder alloy.

Reflow soldering is not a suggested method for through-hole power modules due to many process and reliability concerns, and reflow is prohibited for potting model.

Wave Soldering (Lead-free)

Delta's power modules are designed to be compatible with single-wave or dual wave soldering. The suggested soldering process must keep the power module's internal temperature below the critical temperature of 217C continuously. The recommended wave-soldering profile is shown below:

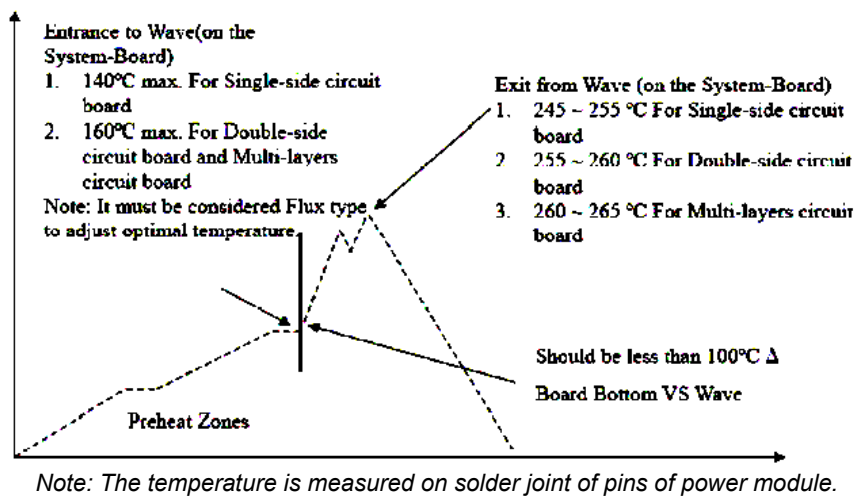

The typical recommended (for double-side circuit board) preheat temperature is 115+/-10C on the top side (component side) of the circuit board. The circuit-board bottom-side preheat temperature is typically recommended to be greater than 135C and preferably within 100C of the solder-wave temperature. A maximum recommended preheat up rate is 3C/s. A maximum recommended solder pot temperature is 255+/-5C with solder-wave dwell time of 3~6 seconds. The cooling down rate is typically recommended to be 6C/s maximum.

Hand Soldering (Lead Free)

Hand soldering is the least preferred method because the amount of solder applied, the time the soldering iron is held on the joint, the temperature of the iron, and the temperature of the solder joint are variable. The recommended hand soldering guideline is listed in Table below. The suggested soldering process must keep the power module's internal temperature below the critical temperature of 217C continuously.

Parameter	Single-side Circuit Board	Double-side Circuit Board	Multi-layers Circuit Board
Soldering Iron Wattage	90	90	90
Tip Temperature	385+/-10°C	420+/-10°C	420+/-10°C
Soldering Time	2 ~ 6 seconds	4 ~ 10 seconds	4 ~ 10 seconds

Reflow Soldering (Lead-free)

High temperature and long soldering time will result in IMC layer increasing in thickness and thereby shorten the solder joint lifetime. Therefore the peak temperature over 245°C is not suggested due to the potential reliability risk of components under continuous high-temperature. In the meanwhile, the soldering time of temperature above 217°C should be less than 90 seconds. Please refer to below figure for recommended temperature profile parameters.

Shielding cap is requested to mount on DCDC module if with heat-spreader/heat-sink, to prevent the customer side high temperature of reflow to re-melt the DCDC module's internal component's soldering joint.

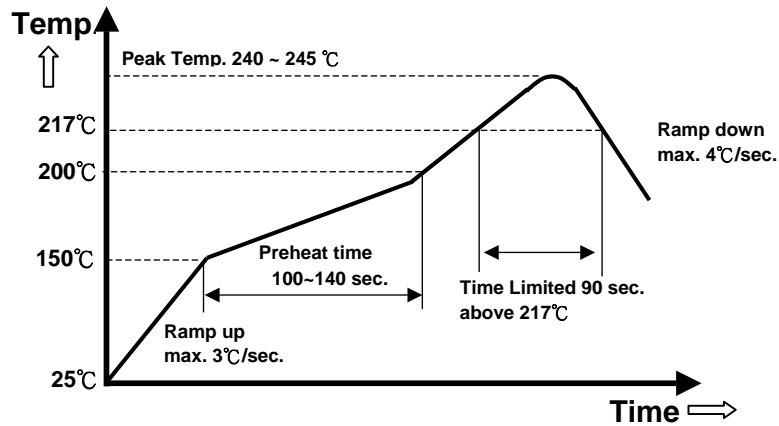

Note: The temperature is measured on solder joint of pins of power module.

Pick and Place Location (For Open Frame Surface Mount Only)

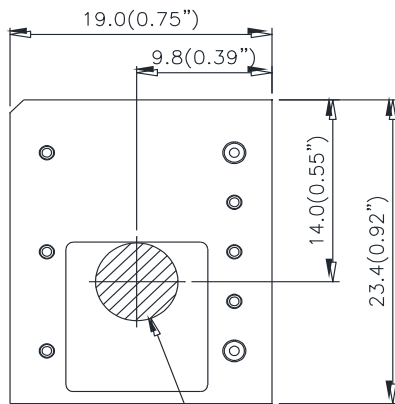

Ø6.0(0.24") MIN AREA

PICK AND PLACE LOCATION

NOTES:

ALL DIMENSIONS ARE IN MILLIMETERS AND (INCHES)

TOLERANCES: X.Xmm±0.5mm(X.XX in.±0.02 in.)

X.XXmm±0.25mm(X.XXX in.±0.010 in.)

Surface-Mount Tape & Reel (For Open Frame Surface Mount Only)

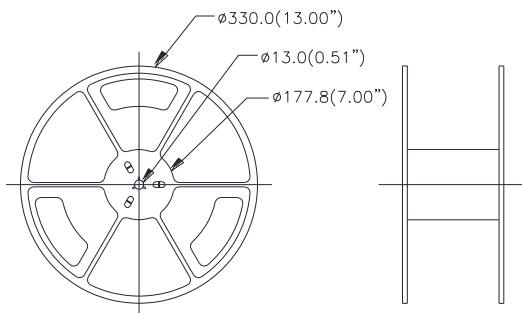
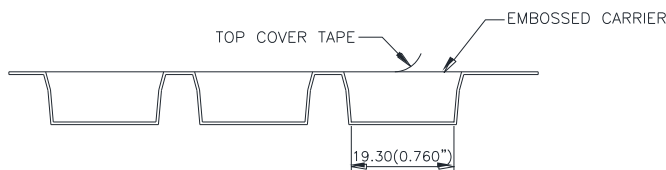
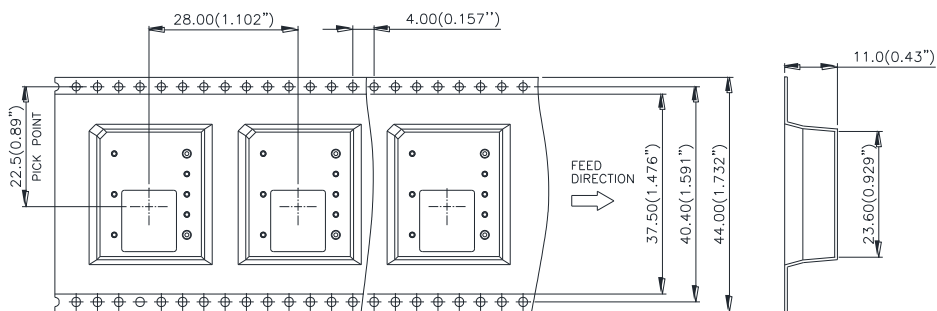

NOTES:

CONFORMS TO EIA-481 STANDARD

MODULES ARE SHIPPED IN QUANTITIES OF 100 PER REEL.

ALL DIMENSIONS ARE IN MILLIMETERS AND (INCHES)

TOLERANCES: X.Xmm±0.5mm(X.XX in.±0.02 in.)

X.XXmm±0.25mm(X.XXX in.±0.010 in.)



PART NUMBERING SYSTEM

PART NUMBERING SYSTEM												
T	31	S	N	240	05	N	N	F	A			
Form Factor	Input Voltage	Number Of Outputs	Product Series	Output Voltage	Max Output Current	ON/OFF Logic	Pin Length	RoHS	Option Code			
T - 1/32 Brick	31 - 9V~53V	S - Single	N - Series Number	240- 5V~30V	05 - 4.5A	P - Positive	N - 0.145" M - SMD	F - RoHS 6/6 (Lead Free)		Power Good	Standard Case (Potting)	Flanged Case (Potting)
									A	No	No	No
									B	Yes	No	No
									C	Yes	Yes	No
									D	No	Yes	No
									E	Yes	No	Yes
									F	No	No	Yes
			N - Negative									

RECOMMENDED PART NUMBER

Model Name	Input	Output	Eff. @ 100% Load
T31SN24005NNFA	9V~53V	5~30V 4.5A	96.5% @ 36Vin/18Vo
T31SN24005NMFA	9V~53V	5~30V 4.5A	96.5% @ 36Vin/18Vo
T31SN24005NNFC	9V~53V	5~30V 4.5A	96.5% @ 36Vin/18Vo

Default remote On/Off logic is negative and pin length is 0.145"

For different remote On/Off logic and pin length, please refer to part numbering system above or contact your local sales office.

For modules with through-hole pins and the optional heat-spreader, and model with potting, they are intended for wave soldering assembly onto system boards; please do not subject such modules through reflow temperature profile.

CONTACT US:

Website: www.deltaww.com/dcdc

Email: dcdc@deltaww.com

USA:

Telephone:
East Coast: 978-656-3993
West Coast: 510-668-5100
Fax: 510-668-0680

Europe:

Telephone: +31-20-800-3900
Fax: +31-20-800-3999

Asia & the rest of world:

Telephone: +886-3-452-6107
Ext. 6221~6226
Fax: +886-3-433-1810

WARRANTY

Delta offers a two (2) year limited warranty. Complete warranty information is listed on our web site or is available upon request from Delta.

Information furnished by Delta is believed to be accurate and reliable. However, no responsibility is assumed by Delta for its use, nor for any infringements of patents or other rights of third parties, which may result from its use. No license is granted by implication or otherwise under any patent or patent rights of Delta. Delta reserves the right to revise these specifications