

SOT-23

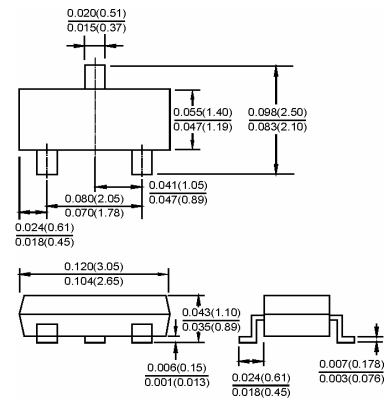

Dimensions in inches and (millimeters)

Features

- ✧ Fast switching speed.
- ✧ Surface mount package ideally suited for
- ✧ Automatic insertion.
- ✧ For general purpose switching applications.
- ✧ High conductance.

Applications

- ✧ High speed switching application.

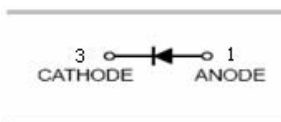

BAS21

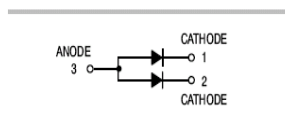

BAS21A

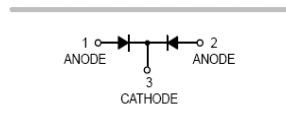

BAS21C

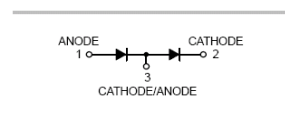

BAS21S

Ordering Information

Type No.	Marking	Package Code
BAS21	JS	SOT-23
BAS21A	JS2	SOT-23
BAS21C	JS3	SOT-23
BAS21S	JS4	SOT-23

MAXIMUM RATING @ Ta=25°C unless otherwise specified

Characteristic	Symbol	Value	Unit
Peak Repetitive Reverse Voltage	V_R	250	V
Forward Continuous Current	I_F	200	mA
Power Dissipation	P_d	250	mW
Thermal Resistance Junction to Ambient Air	$R_{\theta JA}$	500	°C/W
Operating Junction Temperature Range	T_j	150	°C
Storage Temperature Range	T_{STG}	-65 to +150	°C

ELECTRICAL CHARACTERISTICS @ Ta=25°C unless otherwise specified

Characteristic	Symbol	Min	MAX	UNIT	Test Condition
Reverse breakdown Voltage	$V_{(BR)R}$	250	-	V	$I_R=100\mu A$
Reverse Leakage Current	I_R	-	1	μA	$V_R=200V$
Forward voltage	V_F	-	1000 1250	mV	$I_F=100mA$ $I_F=200mA$
Diode Capacitance	C_D	-	5.0	pF	$V_R=0V, f=1.0MHz$
Reverse Recovery Time	t_{rr}	-	50	ns	$I_F=I_R=10mA, t_{rr}=0.1 \cdot I_R$

TYPICAL CHARACTERISTICS @ Ta=25°C unless otherwise specified

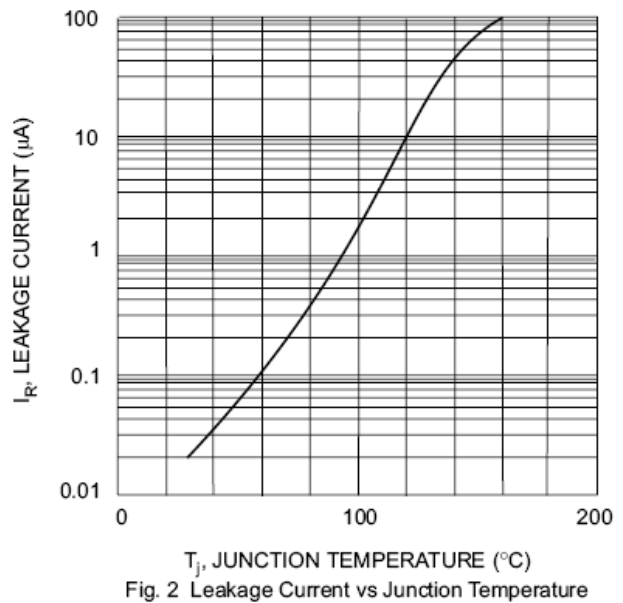
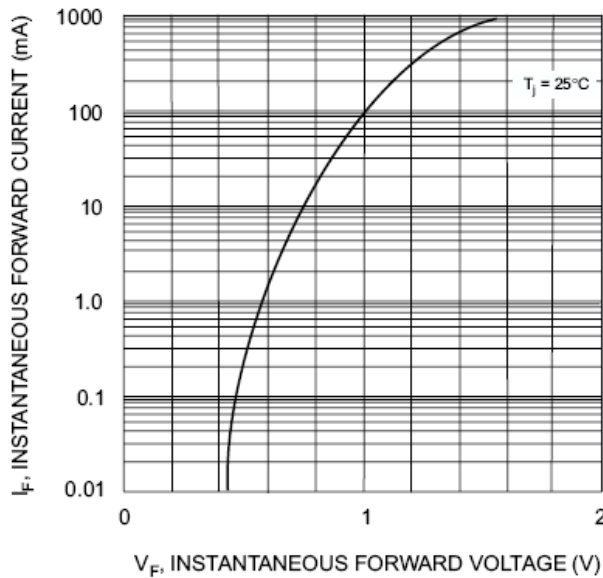

PACKAGE	SPQ/PCS	CARTON SPQ/PCS	CARTON SIZE/CM	CARTON GW/KG	CARTON NW/KG
SOT-23	3000/REEL	90000	40X20X22	5.00	4.00