

Zero-Cross Triac Driver Output Optocoupler

1. Description

The UMW MOC304X series are optically coupled isolators consisting of a GaAs infrared emitting diode coupled with a light activated silicon detector, which functions like a zero voltage crossing bilateral triac driver.

2. Features

- 400V peak blocking voltage
- High isolation voltage between input and output (Viso=5000Vms)
- Zero voltage crossing
- Compact dual in-line package
- Pb free and RoHS compliant
- UL approved: UL1577, file No. E492440

3. Applications

- Solenoid/valve controls
- Lighting controls
- Static power switches
- AC motor drives
- Electromagnetic contactors
- Solid state relays

4. Schematic

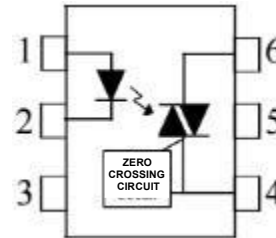

Pin Configuration

1. Anode
2. Cathode
3. No Connection
4. Terminal
5. Substrate (do not connect)
6. Terminal

5. Maximum Ratings (TA=25°C)

Parameter		Symbol	Value	Unit
Input	Forward current	I_F	60	mA
	Reverse voltage	V_R	6	V
	Power dissipation	P_D	100	mW
	Derating factor (above Ta=85°C)		3.8	mW/°C
Output	Off-state output terminal voltage	MOC304X V_{DRM}	400	V
	Peak repetitive surge current (pw=100µs, 120pps)	I_{TSM}	1	A
	On-state R.M.S. current	$I_{T(RMS)}$	100	mA
	Power dissipation	P_C	300	mW
	Derating factor (above Ta=85°C)		7.6	mW/°C
Total power dissipation		P_{tot}	330	mW
Isolation voltage *		Viso	5000	V
Operating temperature		Topr	-55~+100	°C
Storage temperature		Tstg	-55~+125	°C
Welding temperature (10s)		Tsol	260	°C

* AC for 1 minute, R.H.= 40 ~ 60% R.H. In this test, pins 1 & 2 are shorted together, and pins 3 & 4 are shorted together

Zero-Cross Triac Driver Output Optocoupler
6. Electrical characteristics (T_A=25°C unless otherwise specified)

Parameter	Description	Product	Symbol	Conditions	Min	Typ	Max	Unit
Input	Forward voltage		V _F	I _F =30mA	-	-	1.5	V
	Reverse current		I _R	V _R =6V	-	-	10	μA
Output	Peak off-state current	MOC304X	I _{DRM1}	V _{DRM} =rated V _{DRM} , I _F =0mA	-	-	100	nA
	On-state voltage		V _{TM}	I _{TM} =100mA peak, I _F =rated I _{FT}	-	-	3	V
	Critical rate of rise of off-state voltage	MOC304X	dv/dt	V _{PEAK} = rated	1000	-	-	V/μs
	Inhibit voltage (MT1-MT2 voltage above which device will not trigger)		V _{inh}	I _F =rated I _{FT}	-	-	20	V
	Leakage in inhibited state		I _{DRM2}	I _F =rated I _{FT} V _{DRM} =rated V _{DRM} , off state	-	-	500	μA
Transfer characteristics	LED trigger current	MOC3041	I _{FT}	Main terminal voltage = 3V	-	-	15	mA
		MOC3042			-	-	10	
		MOC3043			-	-	5	
	Holding current		I _H		-	280	-	mA

Zero-Cross Triac Driver Output Optocoupler

7. Typical Performance Curves

Figure 1 LED forward voltage vs forward current

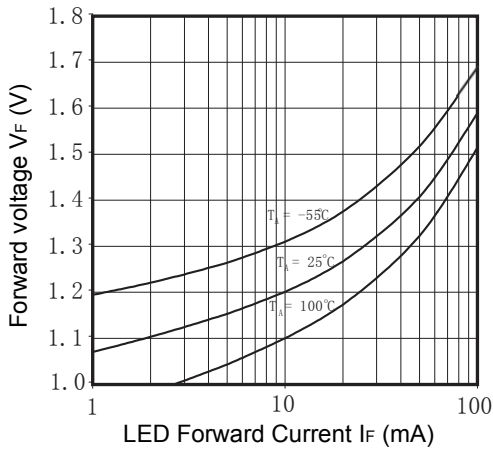

Figure 2 On-state characteristics

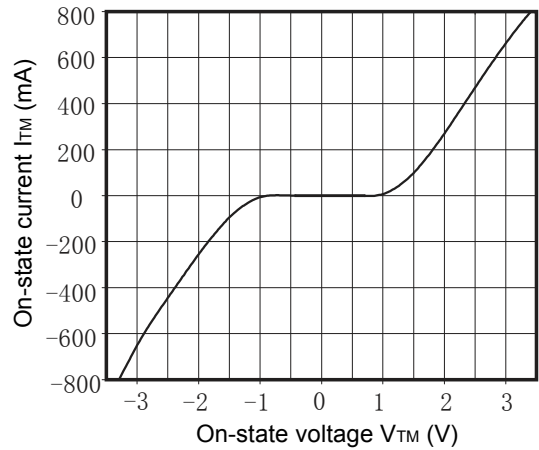

Figure 3 LED trigger current vs ambient temperature

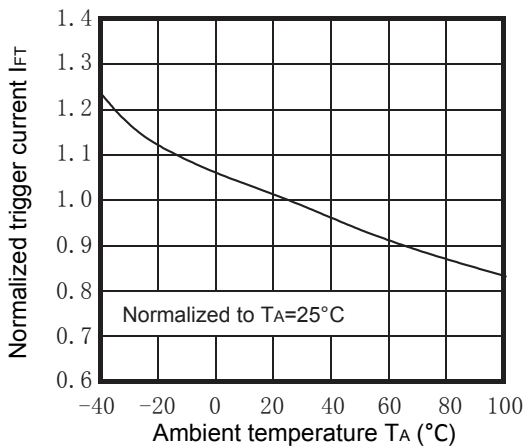

Figure 4 LED trigger current vs. LED pulse width

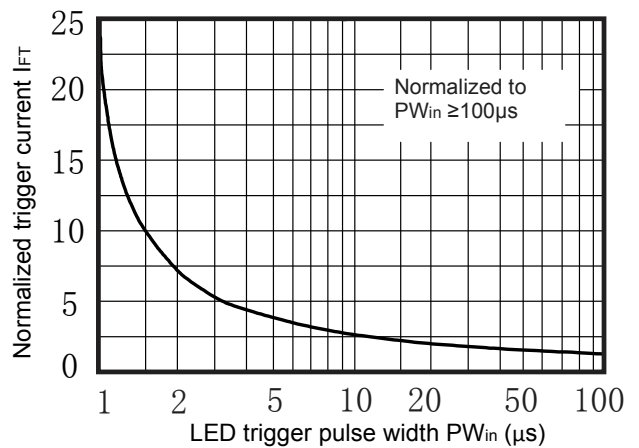

Figure 5 Holding current vs ambient temperature

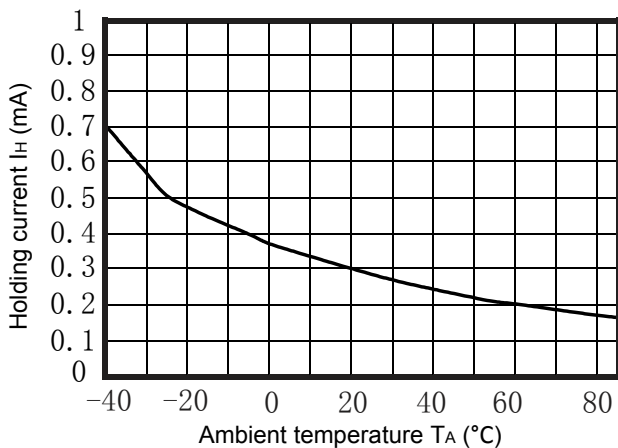
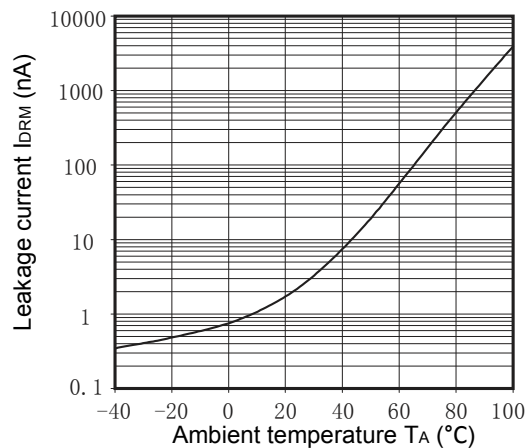

Figure 6 Leakage current vs ambient temperature



Zero-Cross Triac Driver Output Optocoupler

Figure 7 Leakage in inhibited state vs ambient temperature

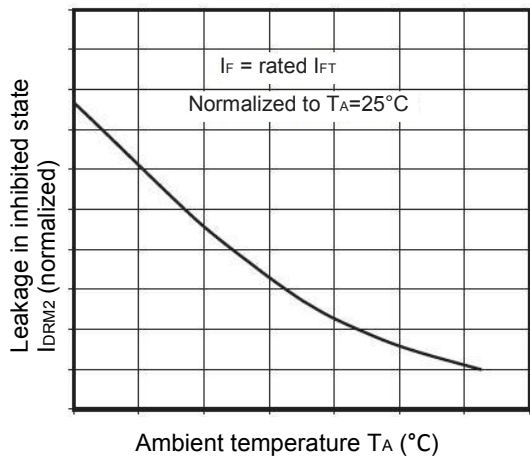

Figure 8 Inhibit voltage vs ambient temperature

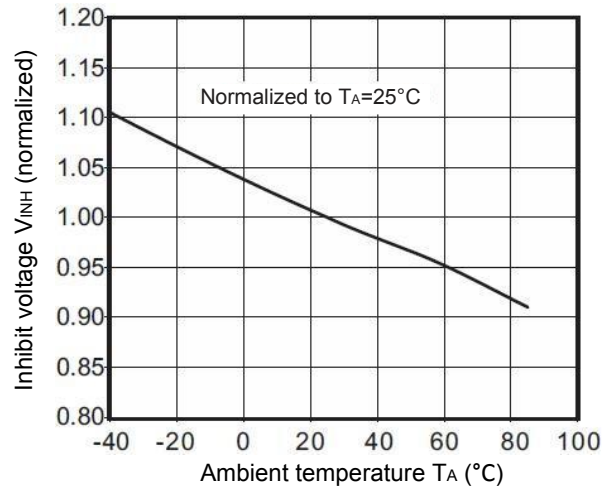
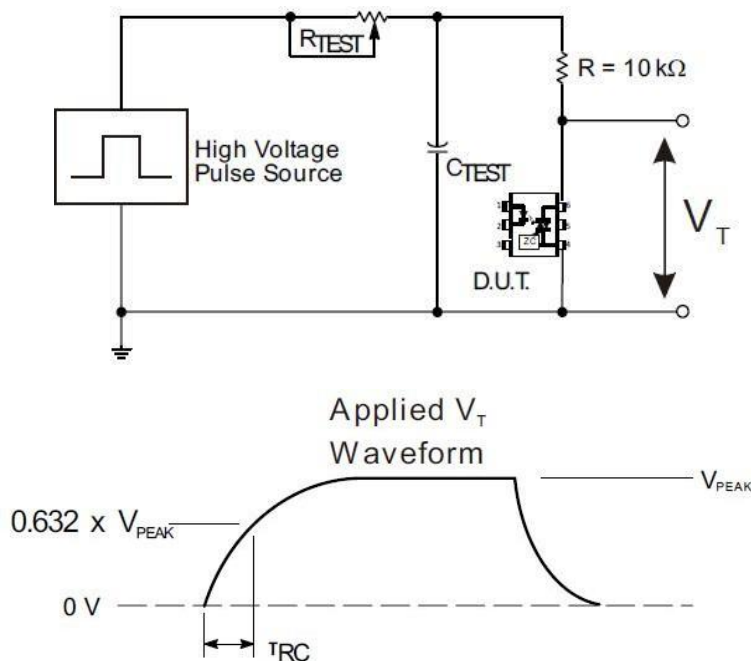

Figure 9 LED Static dv/dt test circuit & waveform



The high voltage pulse is set to the required V_{PEAK} value and applied to the output terminal of the device under test through the RC circuit above. LED current is not applied. The waveform V_T is monitored using a x100 scope probe. By varying R_{TEST} , the dv/dt (slope) is increased, until the device under test is observed to trigger (waveform collapses). The dv/dt is then decreased until the device under test stops triggering. At this point τ_{RC} is recorded and the dv/dt calculated.

$$dv/dt = \frac{0.632 \times V_{PEAK}}{\tau_{RC}}$$

For example, $V_{PEAK} = 400V$ for MOC304X series. The dv/dt value is calculated as follows:

$$dv/dt = \frac{0.632 \times 400}{\tau_{RC}} = \frac{252}{\tau_{RC}}$$

Zero-Cross Triac Driver Output Optocoupler

8. Package dimensions

Unit: mm

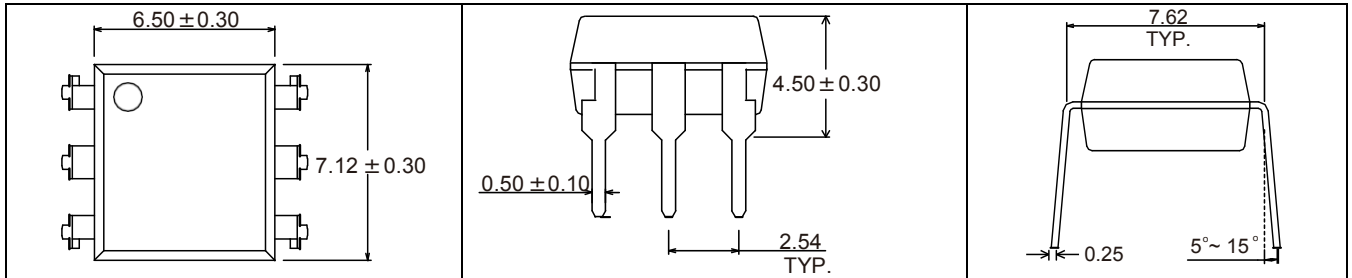

6-pin DIP

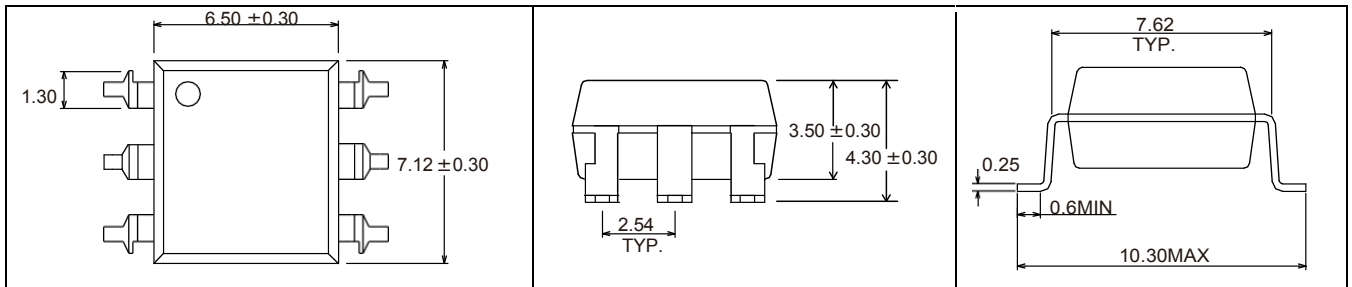

6-pin SOP

9. Marking information

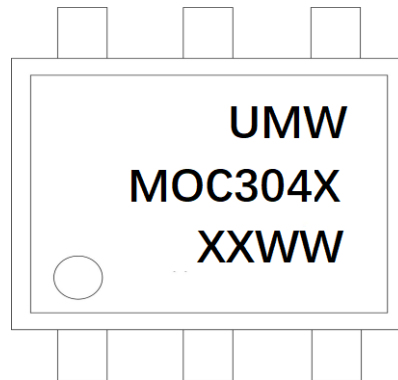

- "X" in the second line represents I_{FT}: 0/1/2/3
- "XX" in the third line represents year code
- "WW" in the third line represents week code

10. Ordering information

Part number	Package	Minimum packing quantity	Packing
UMW MOC304XM	DIP-6	3250	box
UMW MOC304XS	SOP-6	1000	reel

Zero-Cross Triac Driver Output Optocoupler

■ SOP-6 Tape & Reel Packing Specifications

1) Schematic diagram

