

# Random-Phase Triac Driver Output Optocoupler

## 1. Description

The UMW MOC305X series are optically coupled isolators consisting of a GaAs infrared emitting diode coupled with a light activated silicon bilateral switch, which functions like a triac.

## 2. Features

- 600V peak blocking voltage
- High isolation voltage between input and output (Viso=5000Vms)
- Compact dual in-line package
- Pb free and RoHS compliant
- UL approved: UL1577, file No. E492440

## 3. Applications

- Solenoid/valve controls
- Lamp ballasts
- Static AC power switch
- Interfacing microprocessors to 115/240 Vac peripherals
- Incandescent lamp dimmers
- Temperature controls
- Motor controls

## 4. Schematic

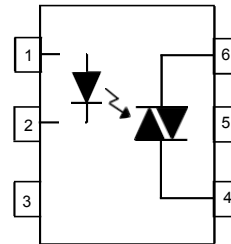

Pin Configuration

1. Anode
2. Cathode
3. No Connection
4. Terminal
5. Substrate (do not connect)
6. Terminal

## 5. Maximum Ratings

Parameter		Symbol	Value	Unit
Input	Forward current	$I_F$	60	mA
	Reverse voltage	$V_R$	6	V
	Power dissipation	$P_D$	100	mW
	Derating factor (above $T_a=85^\circ\text{C}$ )		3.8	mW/ $^\circ\text{C}$
Output	Off-state output terminal voltage	MOC305X $V_{DRM}$	600	V
	Peak repetitive surge current (pw=100 $\mu\text{s}$ , 120pps)	$I_{TSM}$	1	A
		$I_{T(RMS)}$	100	mA
		$P_C$	300	mW
	7.4		mW/ $^\circ\text{C}$	
Total power dissipation		$P_{tot}$	330	mW
Isolation voltage *		Viso	5000	Vrms
Operating temperature		Topr	-55~+100	$^\circ\text{C}$
Storage temperature		Tstg	-55~+125	$^\circ\text{C}$
Welding temperature (10s)		Tsol	260	$^\circ\text{C}$

\* AC for 1 minute, R.H.= 40 ~ 60% R.H. In this test, pins 1 & 2 are shorted together, and pins 3 & 4 are shorted together

**Random-Phase Triac Driver Output Optocoupler**
**6. Electrical characteristics (T<sub>A</sub>=25°C unless otherwise specified)**

Parameter		Symbol	Conditions	Min	Typ	Max	Unit	
Input	Forward voltage	V <sub>F</sub>	I <sub>F</sub> =20mA	-	1.18	1.5	V	
	Reverse current	I <sub>R</sub>	V <sub>R</sub> =6V	-	-	10	μA	
Output	Peak off-state current	I <sub>DRM</sub>	V <sub>DRM</sub> =rated V <sub>DRM</sub> , I <sub>F</sub> =0mA	-	-	100	nA	
	On-state voltage	V <sub>TM</sub>	I <sub>TM</sub> =100mA peak, I <sub>F</sub> =rated I <sub>FT</sub>	-	-	2.5	V	
	Critical rate of rise of off-state voltage	MOC305X	dv/dt	V <sub>PEAK</sub> =400V, I <sub>F</sub> =0	1000	-	-	V/μs
Transfer characteristics	LED trigger current	MOC3051	I <sub>FT</sub>	Main terminal voltage = 3V	-	-	15	mA
		MOC3052			-	-	10	
		MOC3053			-	-	5	
	Holding current		I <sub>H</sub>		-	250	-	μA

# Random-Phase Triac Driver Output Optocoupler

## 7. Typical Performance Curves

Figure 1 LED forward voltage vs forward current

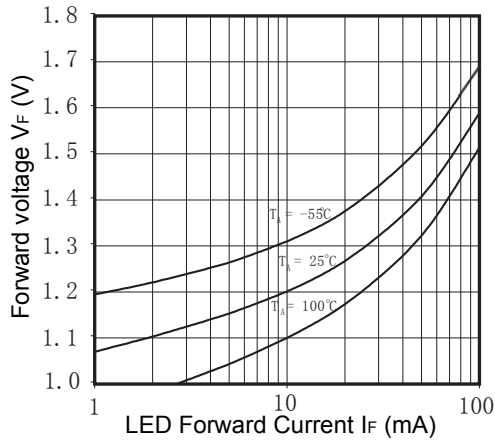

Figure 2 On-state characteristics

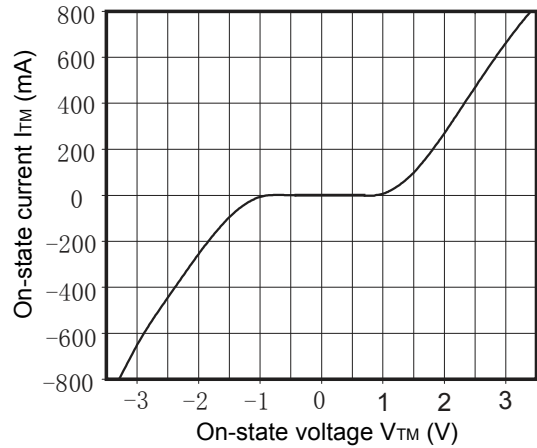

Figure 3 LED trigger current vs ambient temperature

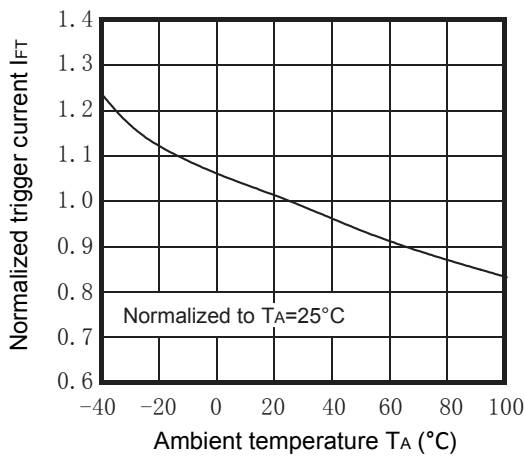

Figure 4 LED trigger current vs. LED pulse width

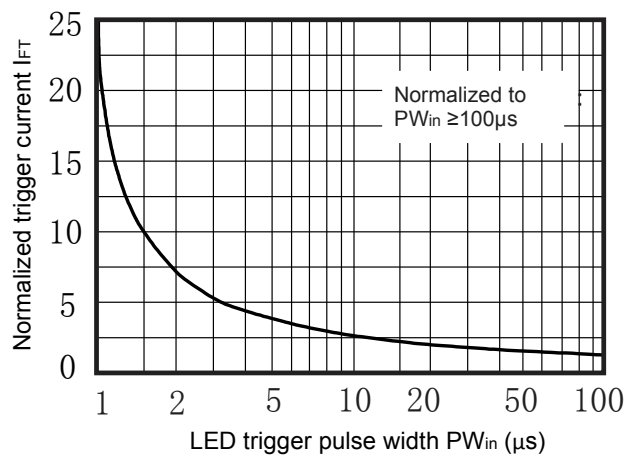

Figure 5 Holding current vs ambient temperature

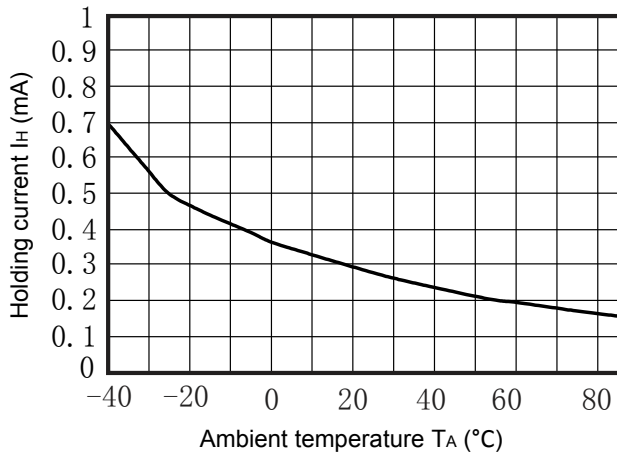
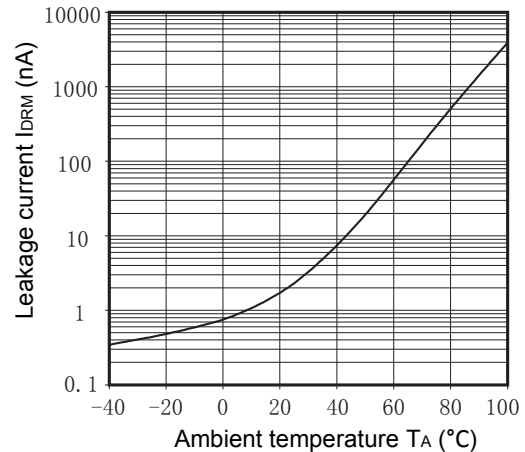
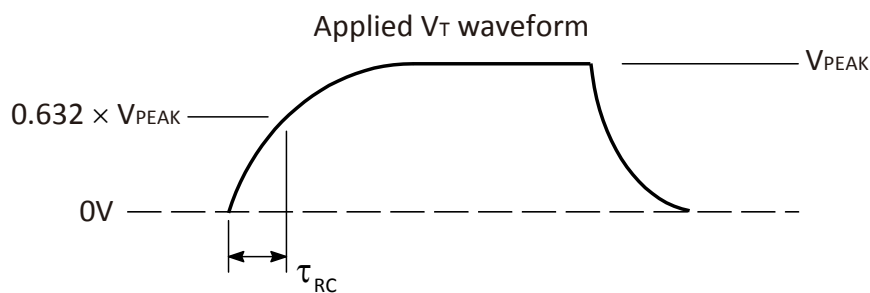
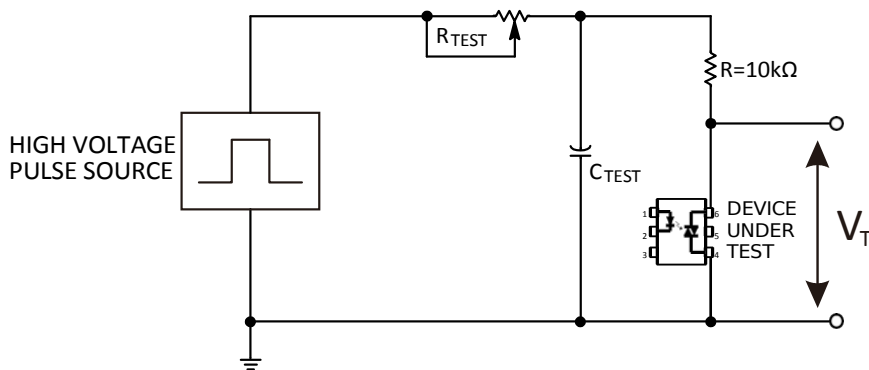

Figure 6 Leakage current vs ambient temperature



Random-Phase Triac Driver Output Optocoupler

Figure 7 LED Static dv/dt test circuit & waveform



The high voltage pulse is set to the required  $V_{PEAK}$  value and applied to the output terminal of the device under test through the RC circuit above. LED current is not applied. The waveform  $V_T$  is monitored using a x100 scope probe. By varying  $R_{TEST}$ , the  $dv/dt$  (slope) is increased, until the device under test is observed to trigger (waveform collapses). The  $dv/dt$  is then decreased until the device under test stops triggering. At this point  $\tau_{RC}$  is recorded and the  $dv/dt$  calculated.

$$dv/dt = \frac{0.632 \times V_{PEAK}}{\tau_{RC}}$$

For example,  $V_{PEAK} = 600V$  for MOC305X series. The  $dv/dt$  value is calculated as follows:

$$dv/dt = \frac{0.632 \times 600}{\tau_{RC}} = \frac{379}{\tau_{RC}}$$

Random-Phase Triac Driver Output Optocoupler

8. Package dimensions

Unit: mm

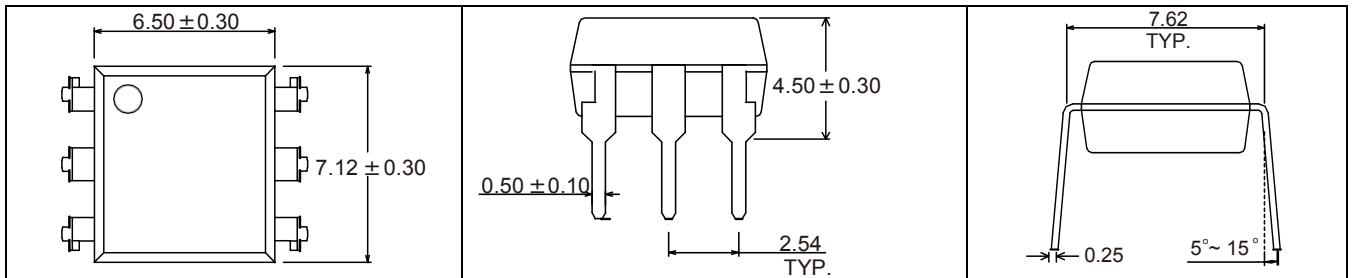

6-pin DIP

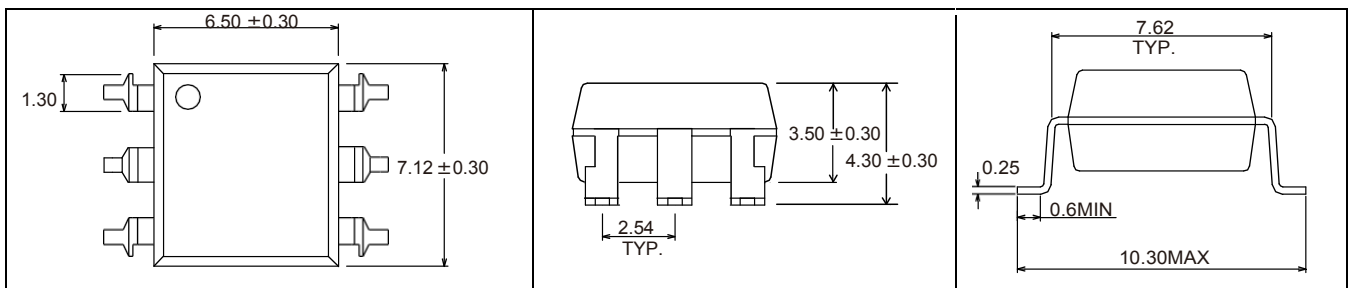

6-pin SOP

9. Marking information

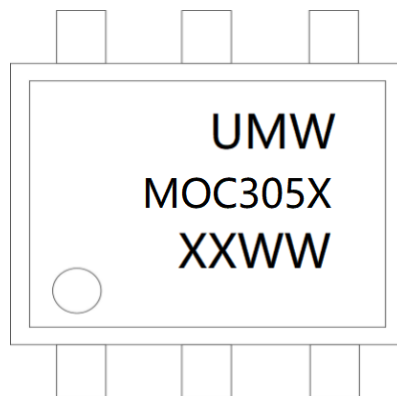

- "X" in the second line represents I<sub>FT</sub>: 0/1/2/3
- "XX" in the third line represents year code
- "WW" in the third line represents week code

10. Ordering information

Part number	Package	Minimum packing quantity	Packing
UMW MOC305XM	DIP-6	3250	box
UMW MOC305XS	SOP-6	1000	reel

Random-Phase Triac Driver Output Optocoupler

■ SOP-6 Tape & Reel Packing Specifications

1) Schematic diagram

