

FOR 客户名称	APPROVED 客户确认签字	ATTN 销售负责人

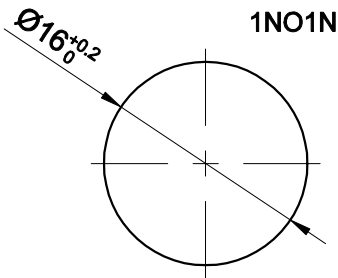

1NO1NC in this way

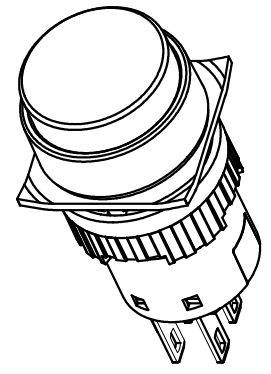
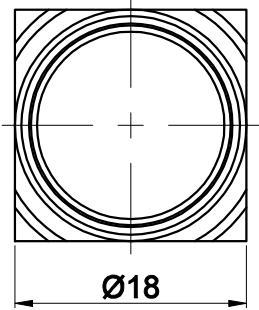
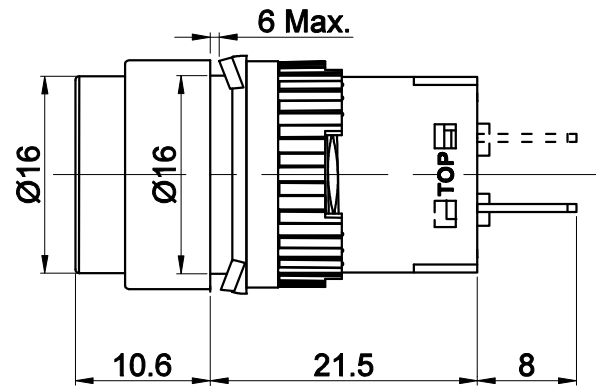
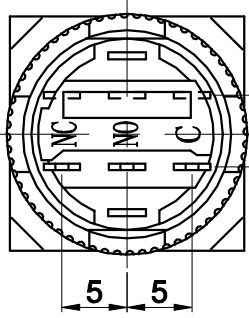
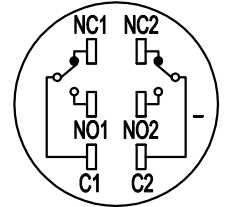

Contact Composition

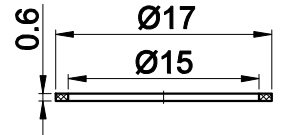

Seal Ring

Part Number: LAS1-AY-□■/△/◎

"△"	Cap Color	"◎"	IP Class
R	Red	P	IP65
G	Green	FP	IP67
Y	Yellow	No Letter	IP40
O	Orange		
B	Blue		
W	White		

**SPECIFICATIONS:**

- Switch Rating: AC220V/0.5A, DC110V/0.1A.
- Mechanical Life: ≥1,000,000cycles(Momentary);  
≥500,000cycles(Latching ).
- Electrical Life: ≥50,000cycles.
- Contact Resistance: ≤50mΩ.
- Insulation Resistance: ≥100MΩ.
- Dielectric Strength:  
Between terminals of the same pole: AC 1,000V, RMS 50Hz, 1min;  
Between terminals of different pole: AC 2,000V, RMS 50Hz, 1min.
- Operating Temperature: -25°C~ +55°C(No Freezing).
- Operating Force: About 1~4N.
- Operating Travel: About 3mm.
- IP Class: IP40、IP65、IP67(with a seal cover).
- Terminal Type: Pin Terminal(2.8 x 0.5mm).

**MATERIALS:**

- Contact: Silver alloy.
- Button: PC.
- Body: PC.
- Base: PBT.

**BRAND 品牌 ONPOW**

THESE DRAWINGS AND SPECIFICATIONS ARE THE PROPERTY OF ONPOW PUSH BUTTON MANUFACTURE CO.,LTD. AND SHALL NOT BE REPRODUCED COPIED OR USED IN ANY MANNER WITHOUT THE PRIOR WRITTEN CONSENT OF ONPOW PUSH BUTTON MANUFACTURE CO.,LTD.

DIMENSIONS	TOLERANCE
0.00 TO 18.00mm	±0.43mm
18.01 TO 30.00mm	±0.52mm
30.01 TO 50.00mm	±0.62mm
50.01 TO 80.00mm	±0.74mm

**红波按钮制造有限公司**  
ONPOW PUSH BUTTON MANUFACTURE CO.,LTD.

USED 用途	APPD 审核	CH 2019/06/10
FINISH 处理	CHKD 校对	NCH 2019/06/10
SCALE 比例 1.6 / 1	UNIT 单位 mm	DR. 制图 ZPD 2019/06/10

TITLE 名称	LAS1-A Series Pushbutton Switches	SIZE 图纸	A4
DWG NO. 图号	LAS1-AY不带灯		
FILE NAME 档案名称	LAS1-A.DWG	SHEET 张	1 / 1
		REV. 更改	1