

双极型线性集成电路

三端1A正电源稳压电路

概述

LM78xx 系列是三端正电源稳压电路，它的封装形式为 TO-263 TO-220。它有一系列固定的电压输出，应用非常的广泛。每种类型由于内部电流的限制，以及过热保护和安全工作区的保护，使它基本上不会损坏。如果能够提供足够的散热片，它们就能够提供大于1.5A的输出电流。虽然是按照固定电压值来设计的，但是当接入适当的外部器件后，就能能获得各种不同的电压和电流。

特点

- *最大输出电流为 1A
- *输出电压为5V;6V;8V;9V;10V;12V;15V;18V;24V
- *热过载保护
- *短路保护
- *输出晶体管安全工作区保护

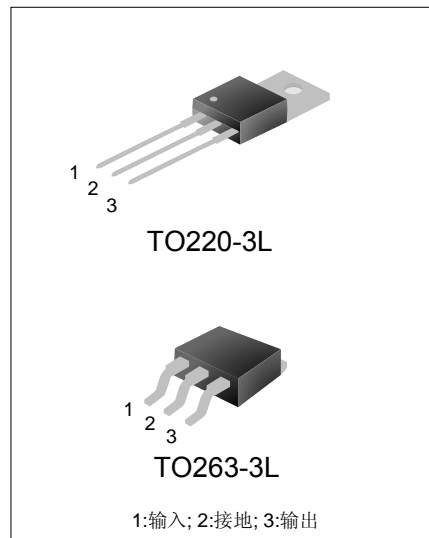

内部框图

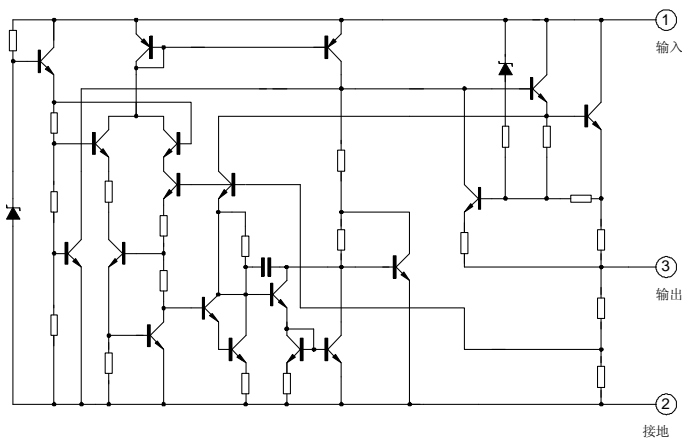

极限参数 (Ta=25°C)

参数	符号	数值	单位
输入电压 (Vo=5V to 18V) (Vo=24V)	Vi	35 40	V V
结到空气热阻	RθJA	65	°C/W
结到壳热阻	RθJC	5	°C/W
工作温度	Topr	0~ +85	°C
贮存温度	Tstg	-65 ~ +150	°C

产品订购信息

产品名称	封装	打印名称	包装	包装数量
LM7805CTG	TO-220-3L	LM7805	管装	1000 只/盒
LM7806CTG		LM7806	管装	1000 只/盒
LM7808CTG		LM7808	管装	1000 只/盒
LM7809CTG		LM7809	管装	1000 只/盒
LM7810CTG		LM7810	管装	1000 只/盒
LM7812CTG		LM7812	管装	1000 只/盒
LM7815CTG		LM7815	管装	1000 只/盒
LM7818CTG		LM7818	管装	1000 只/盒
LM7824CTG		LM7824	管装	1000 只/盒
LM7805CSRG		TO-263-3L	LM7805	编带
LM7806CSRG	LM7806		编带	500 只/盘
LM7808CSRG	LM7808		编带	500 只/盘
LM7809CSRG	LM7809		编带	500 只/盘
LM7810CSRG	LM7810		编带	500 只/盘
LM7812CSRG	LM7812		编带	500 只/盘
LM7815CSRG	LM7815		编带	500 只/盘
LM7818CSRG	LM7818		编带	500 只/盘
LM7824CSRG	LM7824		编带	500 只/盘

LM7805电参数

(除特别说明, $0 < T_j < 125^\circ\text{C}$, $I_o = 500\text{mA}$, $V_i = 10\text{V}$, $C_i = 0.33\mu\text{F}$, $C_o = 0.1\mu\text{F}$)

参数	符号	测试条件	最小值	典型值	最大值	单位
输出电压	V_o	$T_j = 25^\circ\text{C}$	4.8	5.0	5.2	V
		$5.0\text{mA} < I_o < 1.0\text{A}$, $P_o < 15\text{W}$ $V_i = 7.5\text{V to } 20\text{V}$	4.75	5.00	5.25	V
线性调整率	ΔV_o	$T_j = 25^\circ\text{C}$, $V_i = 7.5\text{V to } 25\text{V}$		4.0	100	mV
		$T_j = 25^\circ\text{C}$, $V_i = 8\text{V to } 12\text{V}$		1.6	50	mV
负载调整率	ΔV_o	$T_j = 25^\circ\text{C}$, $I_o = 5.0\text{mA to } 1.5\text{A}$		9	100	mV
		$T_j = 25^\circ\text{C}$, $I_o = 250\text{mA to } 750\text{mA}$		4	50	mV
静态电流	I_Q	$T_j = 25^\circ\text{C}$		5.0	8	mA
静态电流变化率	ΔI_Q	$I_o = 5\text{mA to } 1.0\text{A}$		0.03	0.5	mA
		$V_i = 8\text{V to } 25\text{V}$		0.3	0.8	mA
输出电压温漂	$\Delta V_o / \Delta T$	$I_o = 5\text{mA}$		0.8		mV/ $^\circ\text{C}$
输出噪音电压	V_N	$f = 10\text{Hz to } 100\text{kHz}$, $T_a = 25^\circ\text{C}$		42		μV
纹波抑制比	RR	$f = 120\text{Hz}$, $V_i = 8\text{V to } 18\text{V}$	62	73		dB
输入输出电压差	V_o	$I_o = 1.0\text{A}$, $T_j = 25^\circ\text{C}$		2		V
输出阻抗	R_o	$f = 1\text{kHz}$		15		$\text{m}\Omega$
短路电流	I_{sc}	$V_i = 35\text{V}$, $T_a = 25^\circ\text{C}$		230		mA
峰值电流	I_{pk}	$T_j = 25^\circ\text{C}$		2.2		A

LM7806电参数

(除特别说明, $0 < T_j < 125^\circ\text{C}$, $I_o = 500\text{mA}$, $V_i = 11\text{V}$, $C_i = 0.33\mu\text{F}$, $C_o = 0.1\mu\text{F}$)

参数	符号	测试参数	最小值	典型值	最大值	单位
输出电压	V_o	$T_j = 25^\circ\text{C}$	5.75	6.00	6.25	V
		$5.0\text{mA} < I_o < 1.0\text{A}$, $P_o < 15\text{W}$ $V_i = 8.5\text{V to } 21\text{V}$	5.7	6.0	6.3	V
线性调整率	ΔV_o	$T_j = 25^\circ\text{C}$, $V_i = 8.5\text{V to } 25\text{V}$		5	120	mV
		$T_j = 25^\circ\text{C}$, $V_i = 9\text{V to } 13\text{V}$		1.5	60	mV
负载调整率	ΔV_o	$T_j = 25^\circ\text{C}$, $I_o = 5.0\text{mA to } 1.5\text{A}$		9	130	mV
		$T_j = 25^\circ\text{C}$, $I_o = 250\text{mA to } 750\text{mA}$		3	60	mV
静态电流	I_Q	$T_j = 25^\circ\text{C}$		5.0	8	mA
静态电流变化率	ΔI_Q	$I_o = 5\text{mA to } 1.0\text{A}$			0.5	mA
		$V_i = 9\text{V to } 25\text{V}$			0.8	mA
输出电压温漂	$\Delta V_o / \Delta T$	$I_o = 5\text{mA}$		0.8		mV/ $^\circ\text{C}$
输出噪音电压	V_N	$f = 10\text{Hz to } 100\text{kHz}$, $T_a = 25^\circ\text{C}$		45		μV
纹波抑制比	RR	$f = 120\text{Hz}$, $V_i = 9\text{V to } 19\text{V}$	59	75		dB
输入输出电压差	V_o	$I_o = 1.0\text{A}$, $T_j = 25^\circ\text{C}$		2		V
输出阻抗	R_o	$f = 1\text{kHz}$		19		$\text{m}\Omega$
短路电流	I_{sc}	$V_i = 35\text{V}$, $T_a = 25^\circ\text{C}$		250		mA
峰值电流	I_{pk}	$T_j = 25^\circ\text{C}$		2.2		A

LM7808电参数

(除特别说明, $0 < T_j < 125^\circ\text{C}$, $I_o = 500\text{mA}$, $V_i = 14\text{V}$, $C_i = 0.33\mu\text{F}$, $C_o = 0.1\mu\text{F}$)

参数	符号	测试条件	最小值	典型值	最大值	单位
输出电压	V_o	$T_j = 25^\circ\text{C}$	7.7	8.0	8.3	V
		$5.0\text{mA} < I_o < 1.0\text{A}$, $P_o < 15\text{W}$ $V_i = 11\text{V to } 23\text{V}$	7.6	8.0	8.4	V
线性调整率	ΔV_o	$T_j = 25^\circ\text{C}$, $V_i = 10.5\text{V to } 25\text{V}$		5.0	160	mV
		$T_j = 25^\circ\text{C}$, $V_i = 11\text{V to } 17\text{V}$		2.0	80	mV
负载调整率	ΔV_o	$T_j = 25^\circ\text{C}$, $I_o = 5.0\text{mA to } 1.5\text{A}$		10	160	mV
		$T_j = 25^\circ\text{C}$, $I_o = 250\text{mA to } 750\text{mA}$		5.0	80	mV
静态电流	I_Q	$T_j = 25^\circ\text{C}$		5.0	8	mA
静态电流变化率	ΔI_Q	$I_o = 5\text{mA to } 1.0\text{A}$		0.05	0.5	mA
		$V_i = 11\text{V to } 25\text{V}$		0.5	1.0	mA
输出电压温漂	$\Delta V_o / \Delta T$	$I_o = 5\text{mA}$		0.8		mV/ $^\circ\text{C}$
输出噪音电压	V_N	$f = 10\text{Hz to } 100\text{kHz}$, $T_a = 25^\circ\text{C}$		52		μV
纹波抑制比	RR	$f = 120\text{Hz}$, $V_i = 11.5\text{V to } 21.5\text{V}$	56	73		dB
输入输出电压差	V_o	$I_o = 1.0\text{A}$, $T_j = 25^\circ\text{C}$		2		V
输出阻抗	R_o	$f = 1\text{kHz}$		17		$\text{m}\Omega$
短路电流	I_{sc}	$V_i = 35\text{V}$, $T_a = 25^\circ\text{C}$		230		mA
峰值电流	I_{pk}	$T_j = 25^\circ\text{C}$		2.2		A

LM7809电参数

(除特别说明, $0 < T_j < 125^\circ\text{C}$, $I_o = 500\text{mA}$, $V_i = 15\text{V}$, $C_i = 0.33\mu\text{F}$, $C_o = 0.1\mu\text{F}$)

参数	符号	测试条件	最小值	典型值	最大值	单位
输出电压	V_o	$T_j = 25^\circ\text{C}$	8.65	9.00	9.35	V
		$5.0\text{mA} < I_o < 1.0\text{A}$, $P_o < 15\text{W}$ $V_i = 11.5\text{V to } 24\text{V}$	8.6	9.0	9.4	V
线性调整率	ΔV_o	$T_j = 25^\circ\text{C}$, $V_i = 11.5\text{V to } 25\text{V}$		6	180	mV
		$T_j = 25^\circ\text{C}$, $V_i = 12\text{V to } 25\text{V}$		2	90	mV
负载调整率	ΔV_o	$T_j = 25^\circ\text{C}$, $I_o = 5.0\text{mA to } 1.5\text{A}$		12	180	mV
		$T_j = 25^\circ\text{C}$, $I_o = 250\text{mA to } 750\text{mA}$		4	90	mV
静态电流	I_Q	$T_j = 25^\circ\text{C}$		5.0	8	mA
静态电流变化率	ΔI_Q	$I_o = 5\text{mA to } 1.0\text{A}$			0.5	mA
		$V_i = 12\text{V to } 26\text{V}$			0.8	mA
输出电压温漂	$\Delta V_o / \Delta T$	$I_o = 5\text{mA}$		1		mV/ $^\circ\text{C}$
输出噪音电压	V_N	$f = 10\text{Hz to } 100\text{kHz}$, $T_a = 25^\circ\text{C}$		58		μV
纹波抑制比	RR	$f = 120\text{Hz}$, $V_i = 13\text{V to } 23\text{V}$	56	71		dB
输入输出电压差	V_o	$I_o = 1.0\text{A}$, $T_j = 25^\circ\text{C}$		2		V
输出阻抗	R_o	$f = 1\text{kHz}$		15		$\text{m}\Omega$
短路电流	I_{sc}	$V_i = 35\text{V}$, $T_a = 25^\circ\text{C}$		250		mA
峰值电流	I_{pk}	$T_j = 25^\circ\text{C}$		2.2		A

LM7810 电参数

(除特别说明, $0 < T_j < 125^\circ\text{C}$, $I_o = 500\text{mA}$, $V_i = 16\text{V}$, $C_i = 0.33\mu\text{F}$, $C_o = 0.1\mu\text{F}$)

参数	符号	测试条件	最小值	典型值	最大值	单位
输出电压	V_o	$T_j = 25^\circ\text{C}$	9.6	10	10.4	V
		$5.0\text{mA} < I_o < 1.0\text{A}$, $P_o < 15\text{W}$ $V_i = 12.5\text{V to } 25\text{V}$	9.5	10	10.5	V
线性调整率	ΔV_o	$T_j = 25^\circ\text{C}$, $V_i = 12.5\text{V to } 25\text{V}$		10	200	mV
		$T_j = 25^\circ\text{C}$, $V_i = 13\text{V to } 20\text{V}$		3	100	mV
负载调整率	ΔV_o	$T_j = 25^\circ\text{C}$, $I_o = 5.0\text{mA to } 1.5\text{A}$		12	200	mV
		$T_j = 25^\circ\text{C}$, $I_o = 250\text{mA to } 750\text{mA}$		4	100	mV
静态电流	I_Q	$T_j = 25^\circ\text{C}$		5.0	8	mA
静态电流变化率	ΔI_Q	$I_o = 5\text{mA to } 1.0\text{A}$			0.5	mA
		$V_i = 13\text{V to } 29\text{V}$			0.8	mA
输出电压温漂	$\Delta V_o / \Delta T$	$I_o = 5\text{mA}$		1		mV/ $^\circ\text{C}$
输出噪音电压	V_N	$f = 10\text{Hz to } 100\text{kHz}$, $T_a = 25^\circ\text{C}$		58		μV
纹波抑制比	RR	$f = 120\text{Hz}$, $V_i = 14\text{V to } 24\text{V}$	56	71		dB
输入输出电压差	V_o	$I_o = 1.0\text{A}$, $T_j = 25^\circ\text{C}$		2		V
输出阻抗	R_o	$f = 1\text{kHz}$		17		$\text{m}\Omega$
短路电流	I_{sc}	$V_i = 35\text{V}$, $T_a = 25^\circ\text{C}$		250		mA
峰值电流	I_{pk}	$T_j = 25^\circ\text{C}$		2.2		A

LM7812 电参数

(除特别说明, $0 < T_j < 125^\circ\text{C}$, $I_o = 500\text{mA}$, $V_i = 16\text{V}$, $C_i = 0.33\mu\text{F}$, $C_o = 0.1\mu\text{F}$)

参数	符号	测试条件	最小值	典型值	最大值	单位
输出电压	V_o	$T_j = 25^\circ\text{C}$	11.5	12.0	12.5	V
		$5.0\text{mA} < I_o < 1.0\text{A}$, $P_o < 15\text{W}$ $V_i = 14.5\text{V to } 27\text{V}$	11.4	12	12.6	V
线性调整率	ΔV_o	$T_j = 25^\circ\text{C}$, $V_i = 14.5\text{V to } 30\text{V}$		10	240	mV
		$T_j = 25^\circ\text{C}$, $V_i = 16\text{V to } 22\text{V}$		3	120	mV
负载调整率	ΔV_o	$T_j = 25^\circ\text{C}$, $I_o = 5.0\text{mA to } 1.5\text{A}$		11	240	mV
		$T_j = 25^\circ\text{C}$, $I_o = 250\text{mA to } 750\text{mA}$		5.0	120	mV
静态电流	I_Q	$T_j = 25^\circ\text{C}$		5.1	8	mA
静态电流变化率	ΔI_Q	$I_o = 5\text{mA to } 1.0\text{A}$			0.5	mA
		$V_i = 15\text{V to } 30\text{V}$			0.8	mA
输出电压温漂	$\Delta V_o / \Delta T$	$I_o = 5\text{mA}$		1		mV/ $^\circ\text{C}$
输出噪音电压	V_N	$f = 10\text{Hz to } 100\text{kHz}$, $T_a = 25^\circ\text{C}$		76		μV
纹波抑制比	RR	$f = 120\text{Hz}$, $V_i = 15\text{V to } 25\text{V}$	55	71		dB
输入输出电压差	V_o	$I_o = 1.0\text{A}$, $T_j = 25^\circ\text{C}$		2		V
输出阻抗	R_o	$f = 1\text{kHz}$		18		$\text{m}\Omega$
短路电流	I_{sc}	$V_i = 35\text{V}$, $T_a = 25^\circ\text{C}$		230		mA
峰值电流	I_{pk}	$T_j = 25^\circ\text{C}$		2.2		A

LM7815电参数

(除特别说明, $0 < T_j < 125^\circ\text{C}$, $I_o = 500\text{mA}$, $V_i = 23\text{V}$, $C_i = 0.33\mu\text{F}$, $C_o = 0.1\mu\text{F}$)

参数	符号	测试条件	最小值	典型值	最大值	单位
输出电压	V_o	$T_j = 25^\circ\text{C}$	14.4	15.0	15.6	V
		$5.0\text{mA} < I_o < 1.0\text{A}$, $P_o < 15\text{W}$ $V_i = 17.5\text{V to } 30\text{V}$	14.25	15	15.75	V
线性调整率	ΔV_o	$T_j = 25^\circ\text{C}$, $V_i = 17.5\text{V to } 30\text{V}$		11	300	mV
		$T_j = 25^\circ\text{C}$, $V_i = 20\text{V to } 26\text{V}$		3	150	mV
负载调整率	ΔV_o	$T_j = 25^\circ\text{C}$, $I_o = 5.0\text{mA to } 1.5\text{A}$		12	300	mV
		$T_j = 25^\circ\text{C}$, $I_o = 250\text{mA to } 750\text{mA}$		4	150	mV
静态电流	I_Q	$T_j = 25^\circ\text{C}$		5.2	8	mA
静态电流变化率	ΔI_Q	$I_o = 5\text{mA to } 1.0\text{A}$			0.5	mA
		$V_i = 18\text{V to } 30\text{V}$			0.8	mA
输出电压温漂	$\Delta V_o / \Delta T$	$I_o = 5\text{mA}$		1		mV/ $^\circ\text{C}$
输出噪声电压	V_N	$f = 10\text{Hz to } 100\text{kHz}$, $T_a = 25^\circ\text{C}$		90		μV
纹波抑制比	RR	$f = 120\text{Hz}$, $V_i = 18.5\text{V to } 28.5\text{V}$	54	70		dB
输入输出电压差	V_o	$I_o = 1.0\text{A}$, $T_j = 25^\circ\text{C}$		2		V
输出阻抗	R_o	$f = 1\text{kHz}$		19		$\text{m}\Omega$
短路电流	I_{sc}	$V_i = 35\text{V}$, $T_a = 25^\circ\text{C}$		250		mA
峰值电流	I_{pk}	$T_j = 25^\circ\text{C}$		2.2		A

LM7818电参数

(除特别说明, $0 < T_j < 125^\circ\text{C}$, $I_o = 500\text{mA}$, $V_i = 23\text{V}$, $C_i = 0.33\mu\text{F}$, $C_o = 0.1\mu\text{F}$)

参数	符号	测试条件	最小值	典型值	最大值	单位
输出电压	V_o	$T_j = 25^\circ\text{C}$	17.3	18.0	18.7	V
		$5.0\text{mA} < I_o < 1.0\text{A}$, $P_o < 15\text{W}$ $V_i = 21\text{V to } 33\text{V}$	17.1	18	18.9	V
线性调整率	ΔV_o	$T_j = 25^\circ\text{C}$, $V_i = 21\text{V to } 33\text{V}$		15	360	mV
		$T_j = 25^\circ\text{C}$, $V_i = 24\text{V to } 30\text{V}$		5	180	mV
负载调整率	ΔV_o	$T_j = 25^\circ\text{C}$, $I_o = 5.0\text{mA to } 1.5\text{A}$		15	360	mV
		$T_j = 25^\circ\text{C}$, $I_o = 250\text{mA to } 750\text{mA}$		5.0	180	mV
静态电流	I_Q	$T_j = 25^\circ\text{C}$		5.2	8	mA
静态电流变化率	ΔI_Q	$I_o = 5\text{mA to } 1.0\text{A}$			0.5	mA
		$V_i = 21\text{V to } 32\text{V}$			0.8	mA
输出电压温漂	$\Delta V_o / \Delta T$	$I_o = 5\text{mA}$		1		mV/ $^\circ\text{C}$
输出噪声电压	V_N	$f = 10\text{Hz to } 100\text{kHz}$, $T_a = 25^\circ\text{C}$		110		μV
纹波抑制比	RR	$f = 120\text{Hz}$, $V_i = 22\text{V to } 32\text{V}$	53	69		dB
输入输出电压差	V_o	$I_o = 1.0\text{A}$, $T_j = 25^\circ\text{C}$		2		V
输出阻抗	R_o	$f = 1\text{kHz}$		22		$\text{m}\Omega$
短路电流	I_{sc}	$V_i = 35\text{V}$, $T_a = 25^\circ\text{C}$		250		mA
峰值电流	I_{pk}	$T_j = 25^\circ\text{C}$		2.2		A

LM7824电参数

(除特别说明, $0 < T_j < 125^\circ\text{C}$, $I_o = 500\text{mA}$, $V_i = 33\text{V}$, $C_i = 0.33\mu\text{F}$, $C_o = 0.1\mu\text{F}$)

参数	符号	测试条件	最小值	典型值	最大值	单位
输出电压	V_o	$T_j = 25^\circ\text{C}$	23	24	25	V
		$5.0\text{mA} < I_o < 1.0\text{A}$, $P_o < 15\text{W}$ $V_i = 27\text{V to } 38\text{V}$	22.8	24	25.2	V
线性调整率	ΔV_o	$T_j = 25^\circ\text{C}$, $V_i = 27\text{V to } 38\text{V}$		17	480	mV
		$T_j = 25^\circ\text{C}$, $V_i = 30\text{V to } 36\text{V}$		6	240	mV
负载调整率	ΔV_o	$T_j = 25^\circ\text{C}$, $I_o = 5.0\text{mA to } 1.5\text{A}$		15	480	mV
		$T_j = 25^\circ\text{C}$, $I_o = 250\text{mA to } 750\text{mA}$		5.0	240	mV
静态电流	I_Q	$T_j = 25^\circ\text{C}$		5.2	8	mA
静态电流变化率	ΔI_Q	$I_o = 5\text{mA to } 1.0\text{A}$			0.5	mA
		$V_i = 27\text{V to } 38\text{V}$			0.8	mA
输出电压温漂	$\Delta V_o / \Delta T$	$I_o = 5\text{mA}$		1.5		mV/ $^\circ\text{C}$
输出噪音电压	V_N	$f = 10\text{Hz to } 100\text{kHz}$, $T_a = 25^\circ\text{C}$		160		μV
纹波抑制比	RR	$f = 120\text{Hz}$, $V_i = 28\text{V to } 38\text{V}$	50	67		dB
输入输出电压差	V_o	$I_o = 1.0\text{A}$, $T_j = 25^\circ\text{C}$		2		V
输出阻抗	R_o	$f = 1\text{kHz}$		28		$\text{m}\Omega$
短路电流	I_{sc}	$V_i = 35\text{V}$, $T_a = 25^\circ\text{C}$		230		mA
峰值电流	I_{pk}	$T_j = 25^\circ\text{C}$		2.2		A

测试电路图



图1 测直流电参数电路图



图2 测负载调整率电路图

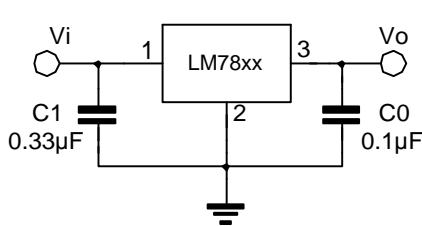

图3 测纹波抑制比电路图

应用电路图

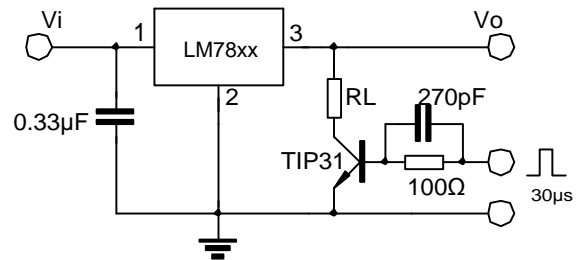
图4 固定输出稳压电路

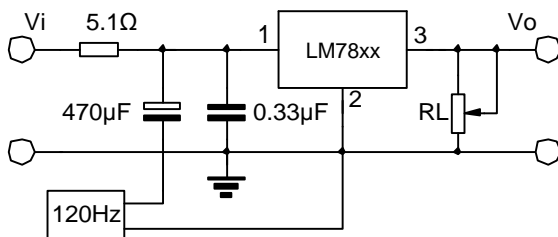

图5 恒流稳压电路

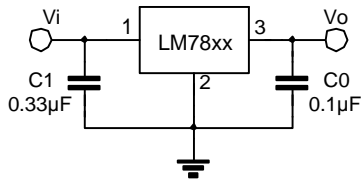

图6 增强型稳压输出电路

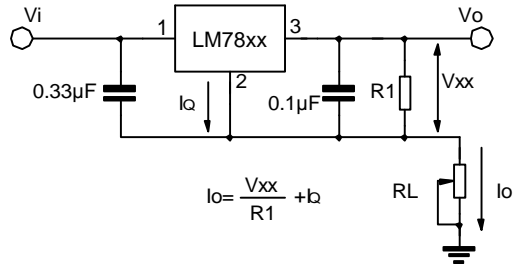

图7 可调型输出电路

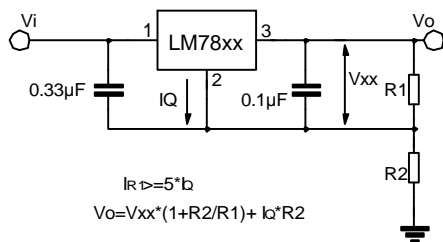

图8 高电流电压稳压电路

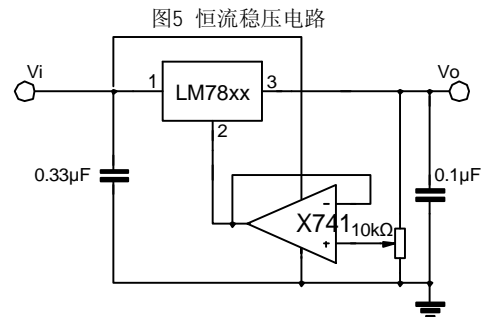

图9 高输出电流短路保护电路

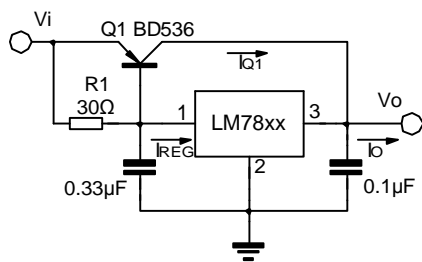

图10 跟踪电压稳压电路

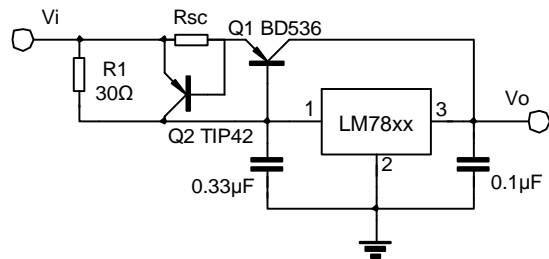

图11 分电源电路(±15V, 1A)

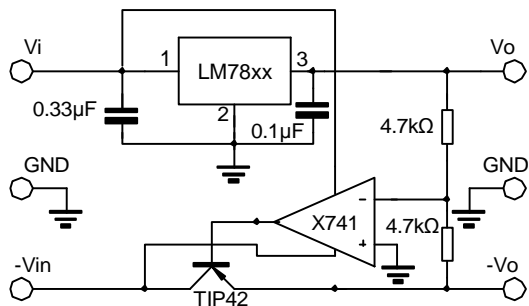

图12 负电源电压输出电路

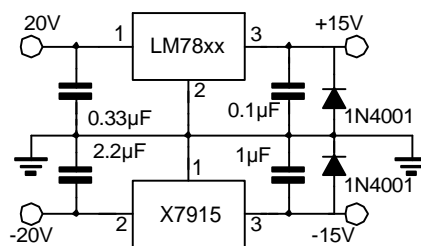

图13 开关稳压电路

典型特性曲线图

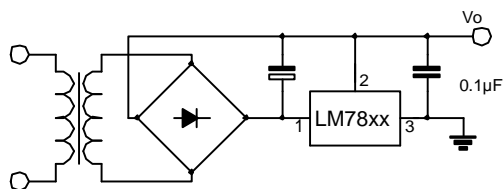
图14 静态电流与结点温度的关系曲线图

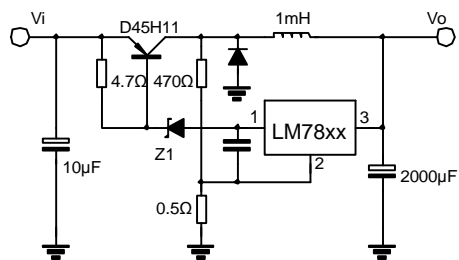

图15 输出电压与结点温度的关系曲线图



图16 峰值输出电流

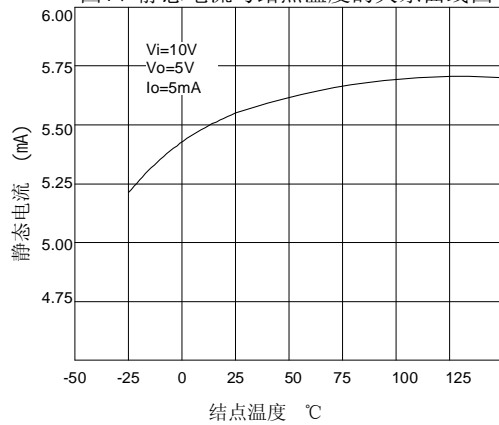

图17 静态电流与输入电压的关系曲线图

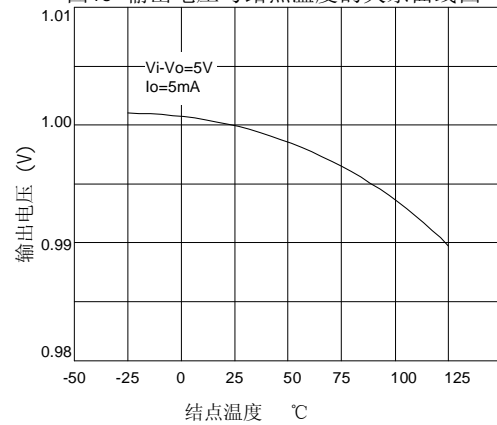

封装外形图：

重要声明:

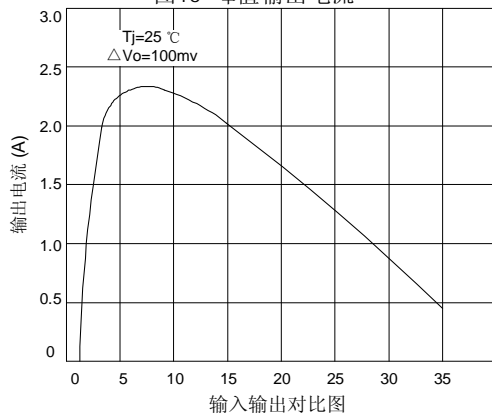
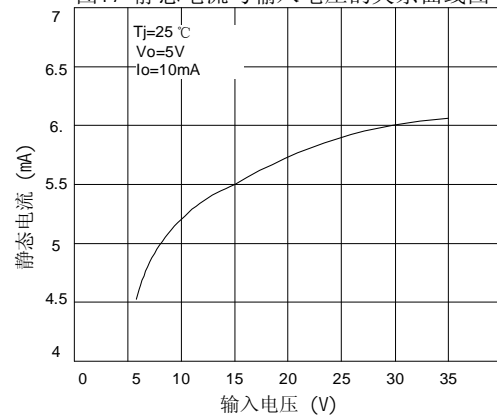
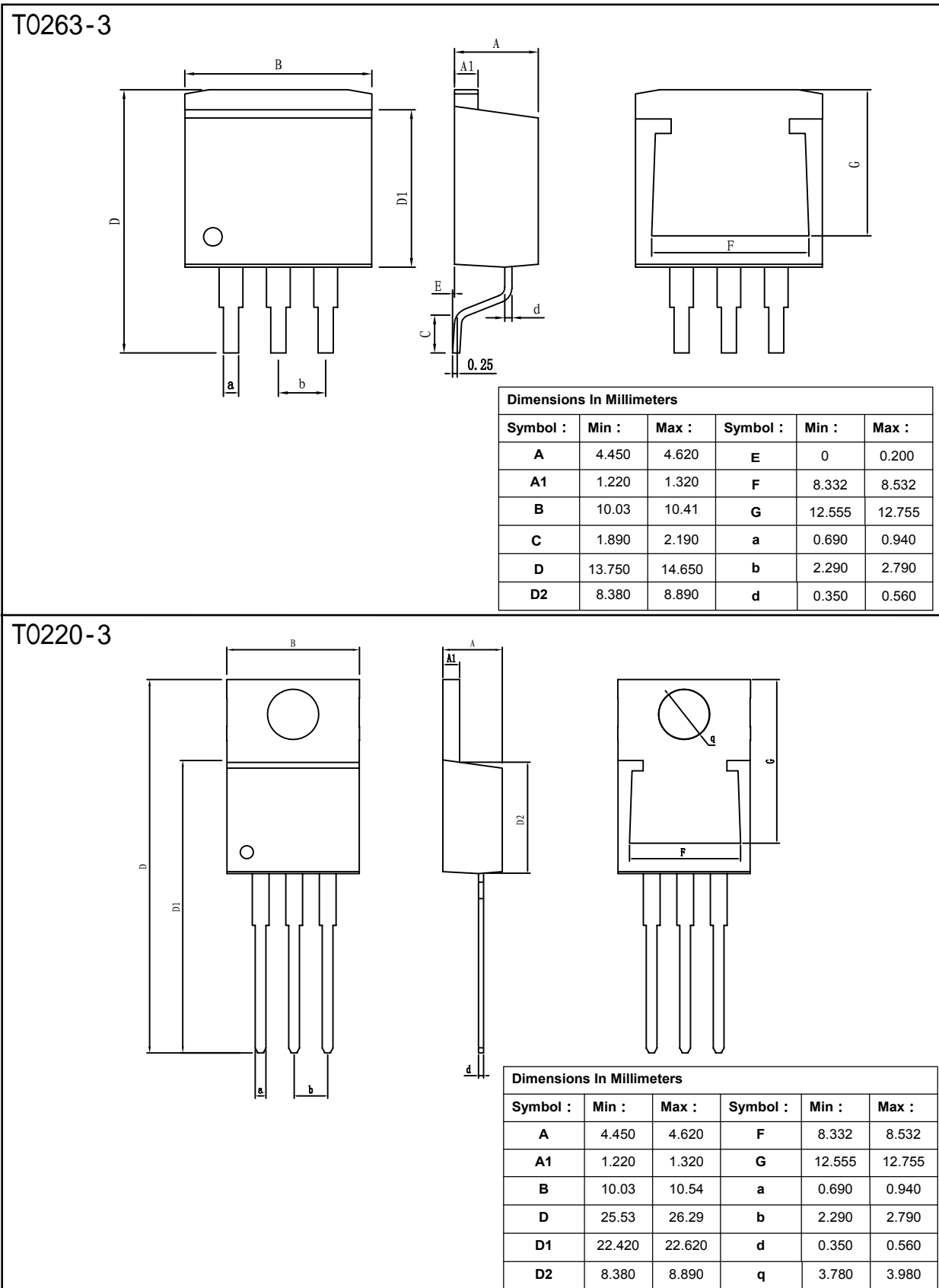
汉芯半导体有限公司保留未经通知更改所提供的产品和服务。客户在订货前应获取最新的相关信息，并核实这些信息是否最新且完整的。

客户在使用汉芯半导体有限公司产品进行系统设计和整机制造时有责任遵守安全标准并采取安全措施，以避免潜在风险可能导致人身伤害或财产损失情况的发生。

汉芯半导体有限公司的产品未获得生命支持、军事、航空航天等领域应用之许可，汉芯半导体有限公司将不承担产品在这些领域应用造成的后果。

汉芯半导体有限公司的文档资料，仅在没有对内容进行任何篡改且带有相关授权的情况下才允许进行复制。汉芯半导体有限公司对篡改过的文件不承担任何责任或义务。