

*Maxair*TM

SPECIFICATIONS

FOR APPROVAL

Model: 12038B3HL

AC380V/50Hz 0.06A

Maxair™

SPECIFICATION

<u>Item</u>	<u>Specification/Condition</u>
Dimension	: 120x120x38 mm
Bearing System	: BALL BEARING
Rated Voltage	: 380 VAC
Operating Voltage	: 350 VAC—400 VAC
Start-up Voltage	: 320 VAC NORMALLY
Rated Current	: 0.06 Amp NORMALLY
Rated Speed	: 2600 RPM±10%
Air Flow	: 91 CFM
Static Air Pressure	: 6.5 mmH ₂ O
Noise Level	: 40dBA
Motor Protection Type	: BY IMPEDANCE
Life Expectance	: 50000 Hours at Room Temperature
Operation Temperature	: -30°C to +75°C
Net Weight	: 530 Grams

Maxair™

MATERIAL

1. Impeller : Thermoplastic PBT of UL 94V-0
2. Bobbin : Thermoplastic PA66 of UL 94V-0
3. Lead Wire : UL 1015 AWG#22 280mm-BLACK

DIMENSIONS: MM

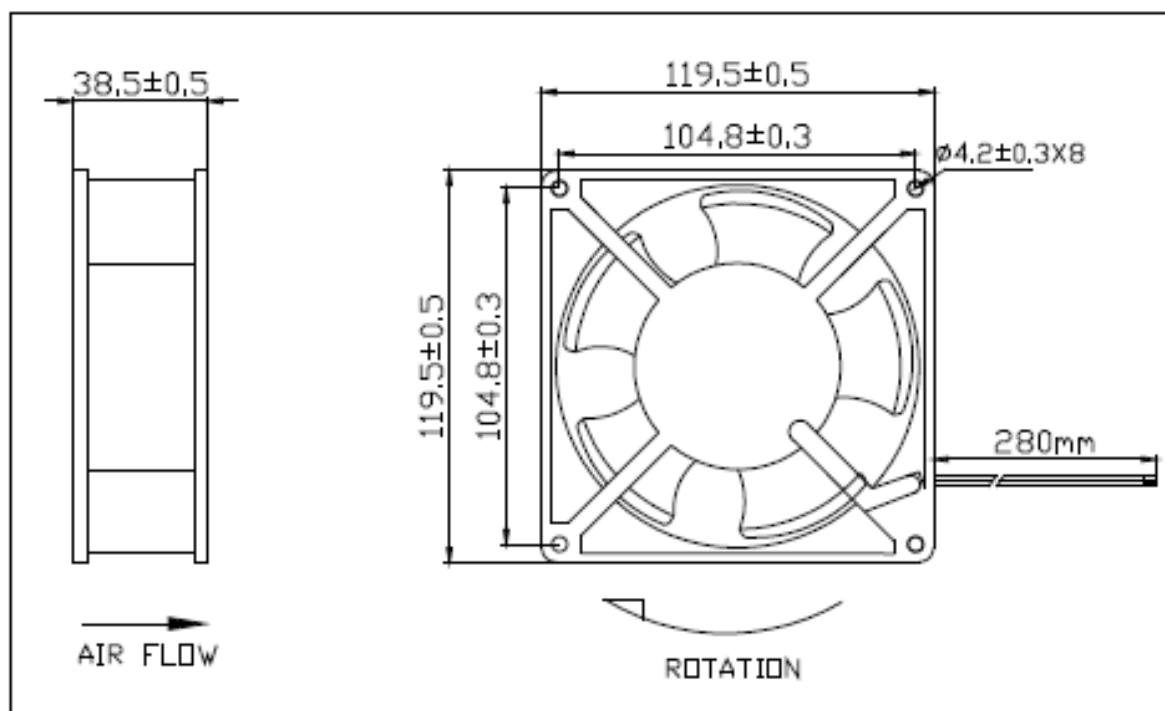

Maxair™

Performance Curve

