

Specifications

- Voltage rating: 150V AC, DC
- Current Rating: 2A, AC, DC
- Withstand voltage: 500V AC/minute
- Contact resistance: 20mΩ max
- Insulation resistance: 500mΩ min
- Temperature range: -25°C ~ +85°C
- Compliant with RoHS and REACH
- Contact JVT for details

Standards



Assembly layout

JVT1505H

1.5mm Pitch housing

HOUSING

Part No.: JVT1505HNO-XXBK

Material: Nylon 66 UL94V-0

Mates With Part(s): JVT1505 Terminal

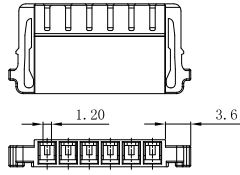

JVT1505HNO-XXBK
 logo
 系列码
 胶壳
 BK-黑色
 PIN数
 PA66 UL94V-0

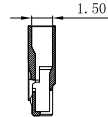
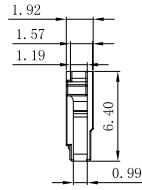
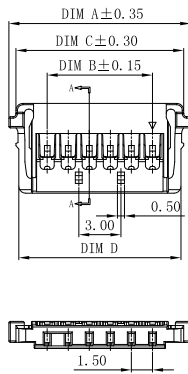

SECTION A-A

CKL	DimA	DimB	DimC	DimD
02	6.95	1.5	5.95	5.55
03	8.45	3.0	7.45	7.05
04	9.95	4.5	8.95	8.55
05	11.45	6.0	10.45	10.05
06	12.95	7.5	11.95	11.55
07	14.45	9.0	13.45	13.05
08	15.95	10.5	14.95	14.55
09	17.45	12.0	16.45	16.05
10	18.95	13.5	17.95	17.55
11	20.45	15.0	19.45	19.05
12	21.95	16.5	20.95	20.55

JVT1505T

1.5mm Pitch Crimp Terminal

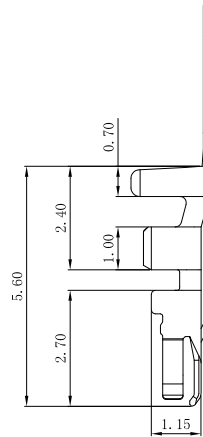
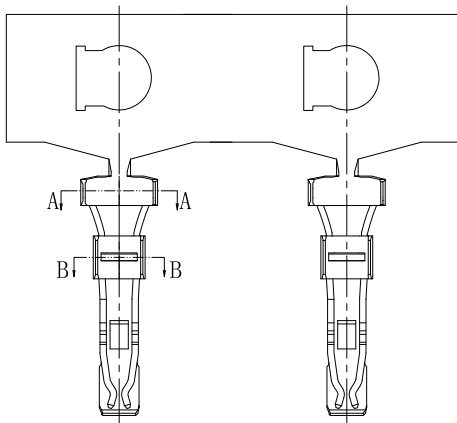

JVT1505TP-XXX
 logo
 系列码
 端子
 磷铜
 S-先冲后镀
 E-先镀后冲
 SN-镀亮锡
 GA-镀全金

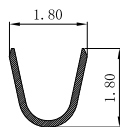

A-A

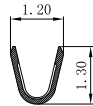

B-B

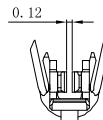

JVT1505TP-GAX	Phos Bronze	Gold Plated	AWG#28-30	0.8mm(Max)	JVT1505 HOUSING
JVT1505TP-SNX		Tin Plated			
PART NO	Material	Finish(Pin)	Wire Range	Insulation O.D.	Mates With Part(s)

JVT1505W

1.5mm Pitch 90°Wafer-SMT TYPE

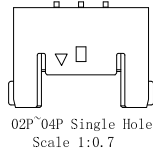
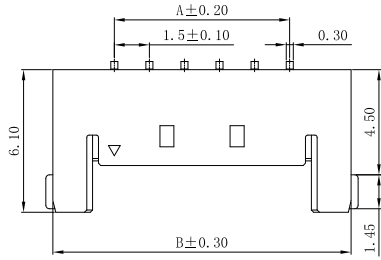

JVT1505W4T-XXGAR-S
 logo 系列码 针座 4T-PA4T
 S-SMT
 R-90°
 GA-镀金
 PIN数

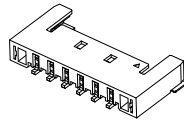
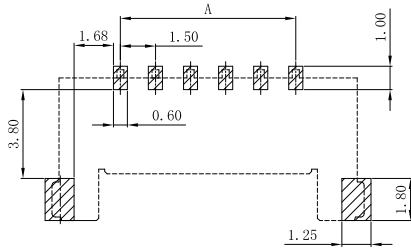
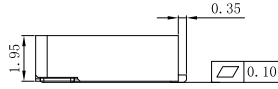
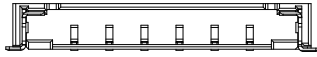

Poles	Dimension (mm)	
	A	B
02	1.50	6.75
03	3.00	8.25
04	4.50	9.75
05	6.00	11.25
06	7.50	12.75
07	9.00	14.25
08	10.50	15.75
09	12.00	17.25
10	13.50	18.75
11	15.00	20.25
12	16.50	21.75

JVT1505W4T-XXGAR-S	LCP	Brass	Gold Plated	Brass	JVT1505 Housing
PART NO	Material	Material(Pin)	Finish(Pin)	Material (Solder Tabs)	Mates With Part(s)