

20mm THRU-HOLE MOUNT COIN CELL HOLDERS

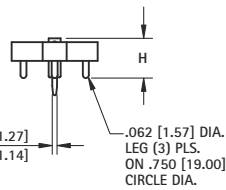

- Advanced air-flow design enhances air circulation around battery
- Reliable spring tension assures low contact resistance
- Unique notched slots assure quick and easy battery insertion and replacement
- Retains battery securely to withstand shock and vibration
- PBT base material UL rated 94V-0. Impervious to most industrial solvents
- Operating temperature range: -60°F to +293°F (-50°C to +145°C)

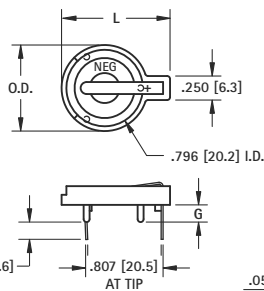

- **Cat. No. 101** is designed to maximize PC Board Capacity
- Unique raised mounting design allows components to be placed underneath the holder
- Ideal when board space is more important than board height; such as PC/104 applicatons

MATERIAL:

Contacts: .020 (.50) Spring Steel, Tin-Nickel Plate
Base: PBT, UL Rated 94V-0

CAT. NO.	G	H	L	O.D.	NO. OF CELLS	BATTERY REFERENCE
103	.100 (2.5)	.335 (8.5)	1.130 (28.7)	.896 (22.8)	(1) cell (any 20mm) (2) 2012, (2) 2016	BR2012, CR2012, CR2016, CL2016, DL2020, CL2025, BR2025, CR2032, CL2032
101	.179 (4.6)	.414 (10.5)	1.130 (28.7)	.896 (22.8)	(1) cell (any 20mm) (2) 2012, (2) 2016	BR2012, CR2012, CR2016, CL2016, DL2020, CL2025, BR2025, CR2032, CL2032
106	.100 (2.5)	.335 (8.5)	1.219 (31.0)	1.093 (27.8)	(1) cell (any 20mm) (2) 2012, (2) 2016	BR2012, CR2012, CR2016, CL2016, DL2020, CL2025, BR2025, CR2032, CL2032
1026	.100 (2.5)	.452 (11.5)	1.219 (31.0)	1.093 (27.8)	(2) 2020, (2) 2025, (2) 2032	DL2020, CR2020, CL2025, BR2025, CR2032, CL2032

Mounting Detail

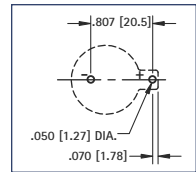

TOP LOADING



- Battery "Pop-in" from top for compact applications
- Finger pressure against lever will release battery
- No tools required for battery changes

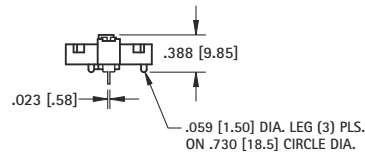
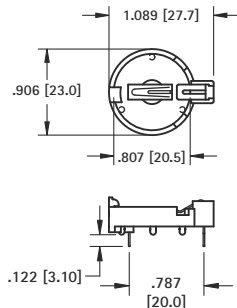

Mounting Detail

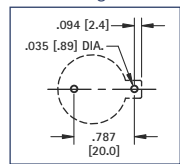

MATERIAL:

Contacts: .016 (.40) Phosphor Bronze, Tin Plate
Base: Nylon UL Rated 94V-0

CAT. NO.	BATTERY REFERENCE
1066	BR2025, CR2032

VERTICAL COMPACT

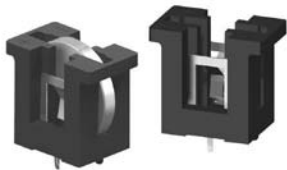

MATERIAL:

Contacts: .012 (.30) Spring Steel, Tin-Nickel Plate
Base: PBT, UL Rated 94V-0

CAT. NO.	BATTERY REFERENCE
1067	CR2016, DL2020, CL2025, CR2032

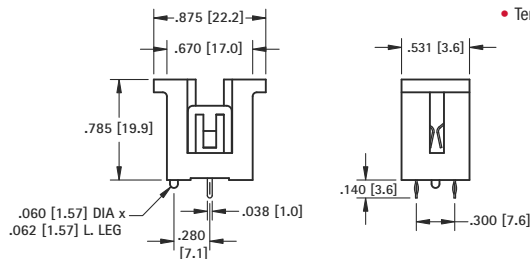

- Accepts all major manufacturers' 20mm diameter batteries
- Molded notch prevents improper insertion of 2032 size cells
- Retains cells securely, withstands shock and vibration
- Polarity clearly marked
- Mounts securely for wave soldering
- Temperature range: -60°F to +293°F (-50°C to +145°C)

Mounting Detail

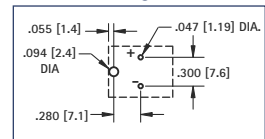

VERTICAL SLIMLINE

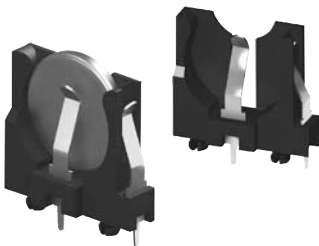

MATERIAL:

Contacts: .016 (.40) Spring Steel, Tin-Nickel Plate
Base: PBT, UL Rated 94V-0

CAT. NO.	BATTERY REFERENCE
1065	BR2012, CR2016, DL2020, CL2025, CR2032

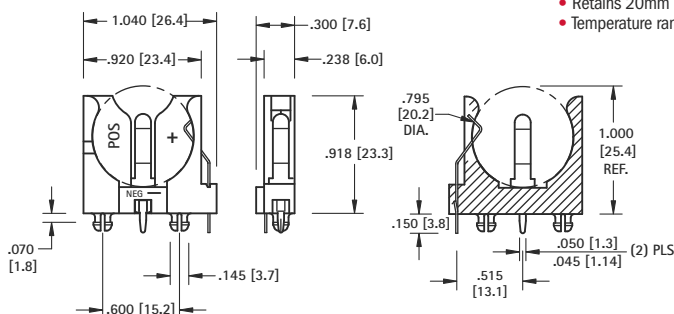

- Polarized holder
- Mounts securely for wave soldering
- Reliable spring tension assures low contact resistance
- Retains 20mm batteries securely to withstand shock and vibration
- Temperature range -60°F to +293°F (-50°C to +145°C)

Mounting Detail

