

## LH SERIES

### 5-25W, AC-DC CONVERTER

LH series ----a compact size power converter offered by Mornsun. It features universal input voltage, taking both DC and AC input voltage, low power consumption, high efficiency, high reliability, safer isolation. It offers good EMC performance, which meet IEC/EN61000-4, CISPR22/EN55022, UL60950 and EN60950 standards, and it's widely used in industrial, office and civil applications. For harsh EMC environment, the application circuit in the datasheet is strongly recommended.



RoHS E235235 CE

### PRODUCT FEATURES

1. Universal input range:85~264VAC, 50/60Hz
2. Regulated output, low ripple and noise
3. Efficiency up to 85%
4. Protection of over-current, short circuit and over-temperature
5. Plastic case, meets UL94V-0
6. Meet UL60950,EN60950 standards
7. 3 years product warranty
8. PCB mounting, Chassis mounting, DIN-Rail mounting

### PART NUMBER SYSTEM

LH10-10B24A2

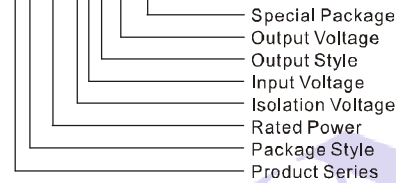

### SELECTION GUIDE

Approval	Model	Package	Power	Output (Vo1/Io1)	Output (Vo2/Io2)	Max. Capacitive Load(μF)		Ripple and Noise (Typ.)	Efficiency (Typ.)				
						Vo1	Vo2						
UL/CE	LH05-10B03	48.5X36X20.5 mm	4W	3.3V/1250mA		32000	--	50mV	70%				
UL/CE	LH05-10B05			5V/1000mA		30000	--		75%				
UL/CE	LH05-10B09			9V/550mA		3800	--		77%				
UL/CE	LH05-10B12			12V/420mA		2500	--		79%				
UL/CE	LH05-10B15			15V/330mA		4300	--		80%				
UL/CE	LH05-10B24			24V/230mA		800	--		82%				
	LH05-10A05		5W	5W	+5V/500mA	-5V/500mA	1480		1480	75%			
	LH05-10A12				+12V/210mA	-12V/210mA	130		130	79%			
	LH05-10A15				+15V/160mA	-15V/160mA	110		110	79%			
	LH05-10A24				+24V/100mA	-24V/100mA	16		16	80%			
	LH05-10C0505-01				5V/800mA	±5V/100mA	2400		370	70%			
	LH05-10C0512-01				5V/600mA	±12V/100mA	1600		170	73%			
	LH05-10C0515-01				5V/600mA	±15V/80mA	1760		80	74%			
	LH05-10C0524-01				5V/600mA	±24V/50mA	1170		50	75%			
	LH05-10D0505-01				5V/900mA	5V/100mA	3360		370	71%			
	LH05-10D0512-01				5V/750mA	12V/100mA	2400		170	73%			
	LH05-10D0515-01				5V/700mA	15V/100mA	2160		170	73%			
	LH05-10D0524-01				5V/600mA	24V/100mA	4560		370	75%			
UL/CE	LH10-10B03				55X45X21.0 mm	6.6 W	3.3V/2000mA			26400	--	50mV	70%
UL/CE	LH10-10B05						5V/2000mA			9440	--		76%
UL/CE	LH10-10B09	9V/1100mA		3600			--	78%					
UL/CE	LH10-10B12	12V/900mA		2400			--	80%					
UL/CE	LH10-10B15	15V/700mA		1170			--	81%					
UL/CE	LH10-10B24	24V/450mA		370			--	82%					
UL/CE	LH10-10A05	10W	10W	+5V/1000mA		-5V/1000mA	8800	8800	76%				
UL/CE	LH10-10A12			+12V/450mA		-12V/450mA	1970	1970	80%				
UL/CE	LH10-10A15			+15V/350mA		-15V/350mA	1970	1970	81%				
UL/CE	LH10-10A24			+24V/200mA		-24V/200mA	660	660	84%				
	LH10-10C0512-02			5V/1000mA		±12V/200mA	3200	260	75%				
	LH10-10C0515-02			5V/900mA		±15V/200mA	2160	80	75%				
UL/CE	LH10-10D0505-02			5V/1800mA		5V/200mA	8000	540	75%				
UL/CE	LH10-10D0512-02			5V/1500mA		12V/200mA	4400	260	79%				
UL/CE	LH10-10D0515-02			5V/1400mA		15V/200mA	4400	170	79%				
UL/CE	LH10-10D0524-02			5V/1000mA		24V/200mA	4000	170	81%				

Approval	Model	Package	Power	Output (Vo1/Io1)	Output (Vo2/Io2)	Max. Capacitive Load ( $\mu$ F)		Ripple and Noise (Typ.)	Efficiency (Typ.)		
						Vo1	Vo2				
UL/CE	LH15-10B03	62X45X22.5 mm	9.9W	3.3V/300mA	--	72000	--	50mV	73%		
UL/CE	LH15-10B05			5V/2800mA	--	44800	--		76%		
UL/CE	LH15-10B09		9V/1600mA	--	13760	--	78%				
UL/CE	LH15-10B12		12V/1250mA	--	5200	--	80%				
UL/CE	LH15-10B15		15V/1000mA	--	5120	--	80%				
UL/CE	LH15-10B24		24V/625mA	--	880	--	84%				
UL/CE	LH15-10B48		48V/320mA	--	370	--	85%				
	LH15-10A05		+5V/1500mA	-5V/1500mA	12800	12800	76%				
	LH15-10A12		+12V/650mA	-12V/650mA	2350	2350	81%				
	LH15-10A15		+15V/500mA	-15V/500mA	3120	3120	83%				
	LH15-10C0505-05		5V/2000mA	$\pm$ 5V/500mA	10800	2160	75%				
	LH15-10C0512-02		5V/2000mA	$\pm$ 12V/200mA	17280	2160	77%				
	LH15-10C0515-02		5V/1800mA	$\pm$ 15V/200mA	5920	370	78%				
	LH15-10C0524-01		5V/2000mA	$\pm$ 24V/100mA	1600	130	78%				
	LH15-10D0505-08		5V/2200mA	5V/800mA	10800	2960	76%				
	LH15-10D0512-04		5V/2000mA	12V/400mA	8640	1200	80%				
	LH15-10D0515-03		5V/2000mA	15V/300mA	6480	800	80%				
	LH15-10D0524-02		5V/2000mA	24V/200mA	12900	800	81%				
UL/CE	LH20-10B03		70x48x23.5 mm	20W	3.3V/4100mA	--	48000		--	50mV	73%
UL/CE	LH20-10B05				5V/3500mA	--	12240		--		75%
UL/CE	LH20-10B09	9V/2100mA		--	7200	--	77%				
UL/CE	LH20-10B12	12V/1600mA		--	5400	--	81%				
UL/CE	LH20-10B15	15V/1300mA		--	2720	--	83%				
UL/CE	LH20-10B24	24V/850mA		--	1840	--	85%				
	LH20-10A05	+5V/2000mA		-5V/2000mA	8000	8000	75%				
	LH20-10A12	+12V/830mA		-12V/830mA	960	960	82%				
	LH20-10A15	+15V/650mA		-15V/650mA	880	880	83%				
	LH20-10C0505-05	5V/2500mA		$\pm$ 5V/500mA	11200	4480	74%				
	LH20-10C0512-04	5V/2000mA		$\pm$ 12V/400mA	16000	1600	75%				
	LH20-10C0515-03	5V/2000mA		$\pm$ 15V/300mA	13520	370	76%				
	LH20-10C0524-02	5V/2000mA		$\pm$ 24V/200mA	11200	370	77%				
	LH20-10D0512-06	5V/2500mA		12V/600mA	32400	3250	75%				
	LH20-10D0515-05	5V/2500mA		15V/500mA	28000	1980	76%				
	LH20-10D0524-03	5V/2500mA		24V/300mA	28000	720	77%				
UL/CE	LH25-10B03	70X48X23.5 mm		25W	3.3V/4100mA	--	48000	--	50mV		73%
UL/CE	LH25-10B05				5V/4100mA	--	12240	--			74%
UL/CE	LH25-10B09				9V/2500mA	--	5600	--			78%
UL/CE	LH25-10B12				12V/2100mA	--	5400	--			82%
UL/CE	LH25-10B15		15V/1600mA		--	2400	--	83%			
UL/CE	LH25-10B24		24V/1100mA		--	1440	--	85%			
UL/CE	LH25-10B48		48V/500mA		--	800	--	87%			

Note: About LH05-10AXX, we use Vo2 as sampling feedback; LH10/15/20-10AXX, use both positive and negative output as sampling feedback; and all others use Vo1 as sampling feedback.

## INPUT SPECIFICATIONS

Item	Test Conditions	Min.	Typ.	Max.	Unit	
Input Voltage Range	AC Input	85	--	264	V	
	DC Input	120	--	370		
Input Frequency		47	--	63	Hz	
Input Current	115VAC Input	LH05 models	--	--	0.125	A
		LH10 models	--	--	0.26	
		LH15 models	--	--	0.37	
		LH20 models	--	--	0.6	
		LH25 models	--	--	0.6	

Input Current	230VAC Input	LH05 models	--	--	0.08	A
		LH10 models	--	--	0.16	
		LH15 models	--	--	0.22	
		LH20 models	--	--	0.34	
		LH25 models	--	--	0.34	
Inrush Current	115VAC Input	LH05 models	--	10	--	
		LH10 models	--	10	--	
		LH15 models	--	10	--	
		LH20/LH25 models	--	16	--	
	230VAC Input	LH05 models	--	20	--	
		LH10 models	--	20	--	
		LH15 models	--	20	--	
		LH20/LH25 models	--	30	--	
Leakage current			0.3mA RMS typ./230VAC/50Hz			
Recommended External Input Fuse (Special package series include fuse)	LH05 models		1A/250V,slow-blow			
	LH10/LH15 models		2A/250V,slow-blow			
	LH20/LH25 models		3.15A/250V,slow-blow			

## OUTPUT SPECIFICATIONS

Item	Test Conditions	Min.	Typ.	Max.	Unit		
Output Voltage Accuracy	main output	--	±2	--	%		
Line Regulation	(main output)	Full load	--	±0.5		--	
	(Secondary output)		--	±1.5		--	
Load Regulation	(10%~100%) load	Single output models (balanced load)		--		±1	--
		Dual output models (balanced load)		--		±2	--
		Isolated triple output (balanced load)	main output Vo1	--		±3	--
			Secondary output ±Vo2	--		±5	--
		Isolated and separated twin output (balanced load)	main output Vo1	--		±3	--
Secondary output Vo2	--		±5	--			
Ripple& Noise	20MHz Bandwidth(p-p)	--	50	100		mV	
Min. Load	Single output models	0	--	--		%	
	Dual output models (balanced load)	10	--	--			
	Isolated and separated twin output (balanced load)	10	--	--			
	Isolated triple output (balanced load)	10	--	--			
Hold-up Time	115VAC Input	--	15	--	ms		
	230VAC Input	--	80	--			
Short Circuit Protection		Continuous, and auto resume					
Over Current Protection		≥110% Io					
Over Voltage Protection	3.3 / 5VDC Output	≤7.5VDC					
	9VDC Output	≤12VDC					
	12 / 15VDC Output	≤20VDC					
	24VDC Output	≤30VDC					
	48VDC Output	≤60VDC					

## COMMON SPECIFICATIONS

Item	Test Conditions	Min.	Typ.	Max.	Unit
Operating Temperature		-40	--	+70	°C
Storage Temperature		-40	--	+105	
Case Temperature		--	--	+90	
Storage Humidity		--	--	95	%RH
Temperature coefficient	main output	--	±0.02	--	%/°C

Power derating	55°C~+70°C		3.75	--	--	
	-40°C~-10°C		2.0	--	--	
Isolation Resistance			100	--	--	MΩ
Isolation Voltage	Input-Output	Tested for 1 minute	3000	--	--	VAC
Switching Frequency			--	65	--	kHz
Welding Temperature	Wave-soldering		260± 5°C; time:5~10s			
	Manual-welding		360± 10°C; time:3~5s			
Safety approvals			EN60950 ,UL60950			
Safety Class	LH15-10BXX		CLASS II			
	Others		CLASS I			
Safety approvals			IEC60950/EN60950/UL60950			
Hot swap			Forbid			
Case Material Grade			UL 94V-0			
Install			PCB mounting, A2 Chassis mounting , A3 Chassis mounting A4 DIN-Rail mounting			
Cooling			Free air convection			
MTBF			>300000h @ 25°C			
Note: 1. Ripple and Noise are measured by the method of parallel lines; 2. Unless otherwise specified, all specifications above are measured at rated input voltage and rated output load, Ta=25°C, humidity < 75%. 3. All characteristics are for listed models, and non-standard models may perform differently. Please contact our technical support for more details.						

## EMC SPECIFICATIONS

EMI	CE	CISPR22/EN55022, CLASS B			
	RE	CISPR22/EN55022, CLASS B			
EMS	ESD	IEC/EN 61000-4-2	±6KV / ±8KV		perf. Criteria B
	RS	IEC/EN 61000-4-3	10V/m		perf. Criteria A
	EFT	IEC/EN 61000-4-4	± 2KV(Without External Circuit )		perf. Criteria B
		IEC/EN 61000-4-4	± 4KV(Recommended Circuit Refer to Figure 3)		perf. Criteria B
	Surge	IEC/EN 61000-4-5	±1KV/±2KV(Without External Circuit )		perf. Criteria B
		IEC/EN 61000-4-5	±2KV/±4KV(Recommended Circuit Refer to Figure 3)		perf. Criteria B
	CS	IEC/EN61000-4-6	10 Vr.m.s		perf. Criteria A
	PFM	IEC/EN61000-4-8	10A/m		perf. Criteria A
Voltage dips, short and interruptions immunity	IEC/EN61000-4-11	0%-70%		perf. Criteria B	

## PARALLEL LINES MEASURE

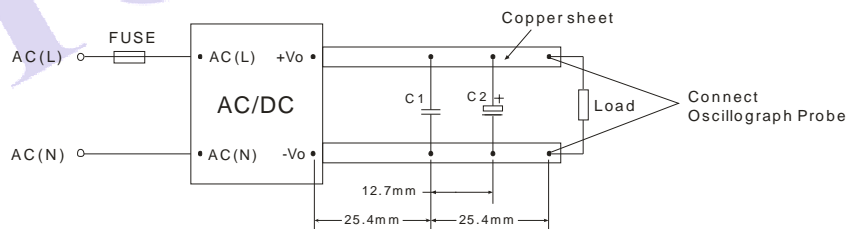

Note: C1: 1μF (Ceramic capacitor) C2: 10μF (Electrolytic capacitor)

## PRODUCT TYPICAL CURVE

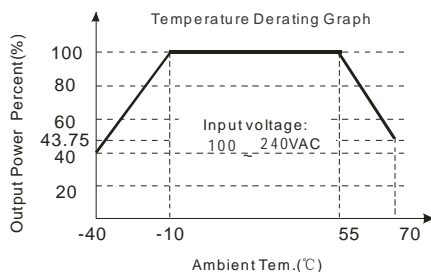

Note: When input 85~100VAC/240~264VAC, it need to be voltage derated on basis of temperature derating.

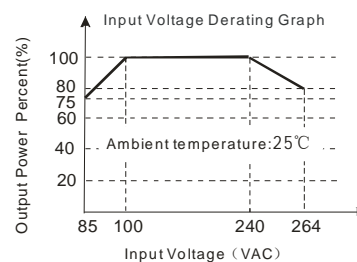

Note: When input DC, VDC=1.414\*VAC-20.

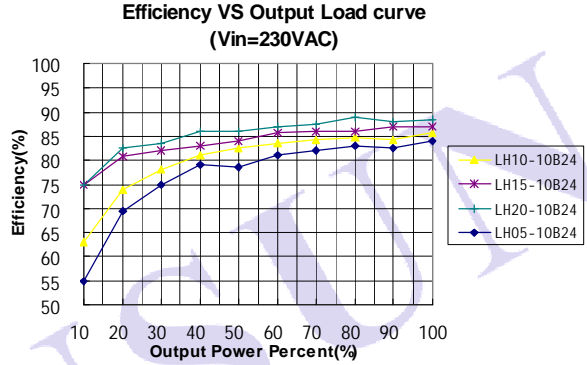
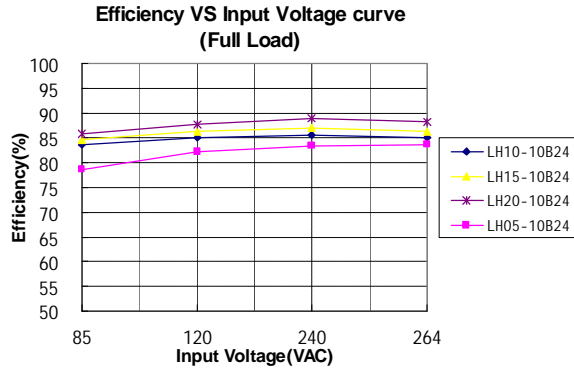
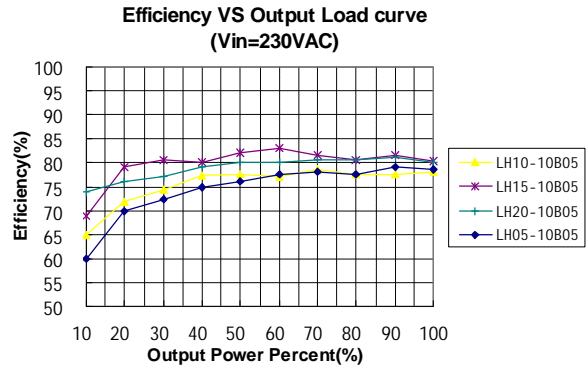
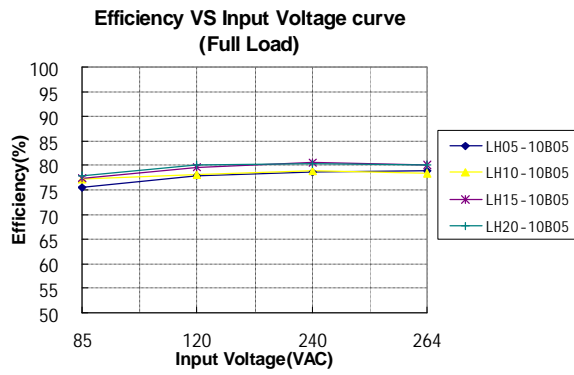

## TRIM APPLICATION & TRIM CALCULATION

Application circuit for TRIM  
(Part in broken line is the interior of models)

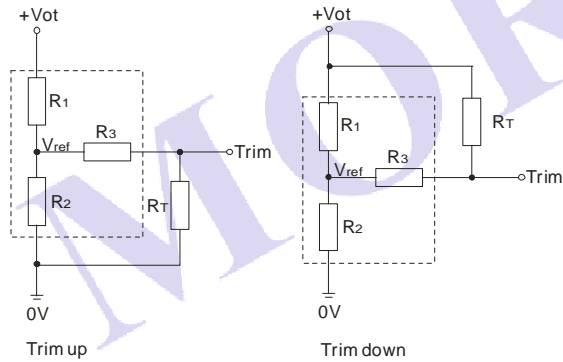

Formula for resistance of Trim:

$$\text{up: } R_T = \frac{aR_2}{R_2 - a} - R_3 \quad a = \frac{V_{ref}}{V_{ot} - V_{ref}} \cdot R_1$$

$$\text{down: } R_T = \frac{aR_1}{R_1 - a} - R_3 \quad a = \frac{V_{ot} - V_{ref}}{V_{ref}} \cdot R_2$$

Note: Value for R1, R2, R3, and Vref refer to the following table.

R<sub>T</sub>: Resistance of Trim

a: User-defined parameter, no actual meanings.

Vo(V) Resistance	3.3	5	9	12	15	24	48
R1(KΩ)	3.3	3.3	7.5	3.83	7.5	8.66	68
R2(KΩ)	1.98	3.3	2.87	1	1.5	1	3.73
R3(KΩ)	1	1	1	1	1	1	1
Vref(V)	1.24	2.5	2.5	2.5	2.5	2.5	2.5
Vot(V)	Output voltage of Trim, variation ≤ ±10%						

## TYPICAL APPLICATIONS

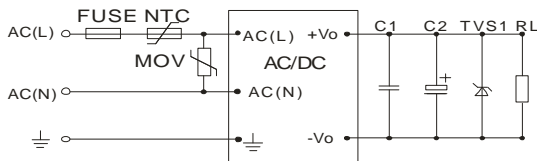

(Figure 1): LHxx-10BxxT (Single Output) series typical application circuit

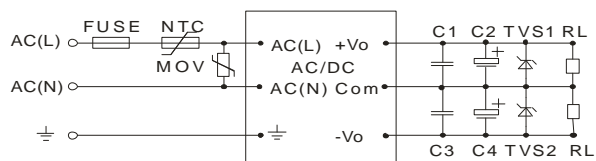

(Figure 2): LHxx-10Axx (Dual Output) series typical application circuit

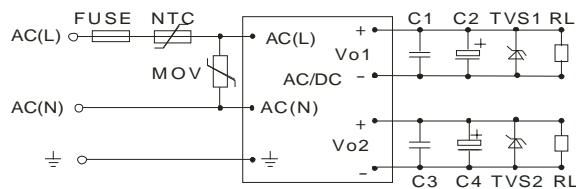

(Figure 3): LHxx-10Dxx(Isolate Twin Output) series typical application circuit

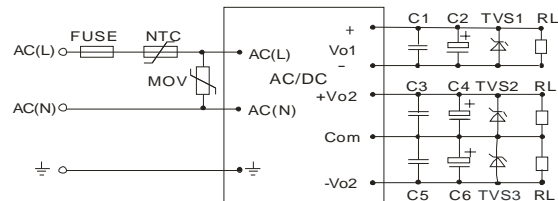

(Figure 4): LHxx-10Cxx(Triple Output) series typical application circuit

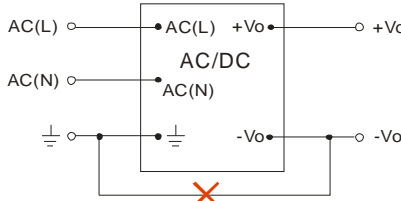

(Figure 5): This application is not available for this series.  
Note: If you have such application, please consult to our FAE department

## EMC RECOMMENDED CIRCUIT

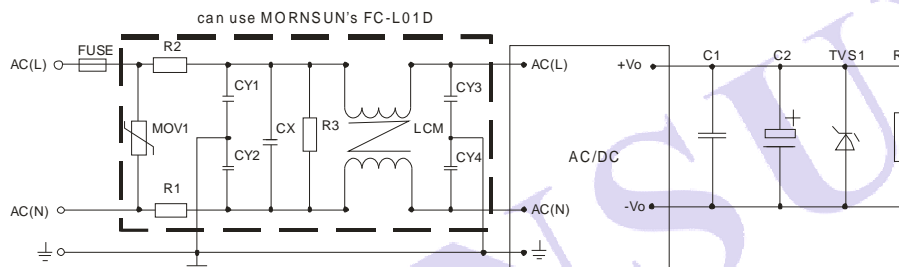

(Figure 6): Recommended circuit for applications which require higher EMC standard  
(External output circuit please refer to figure 1 or figure 2 or figure 3 or figure 4)

## EMC RECOMMENDED CIRCUIT PCB LAYOUT

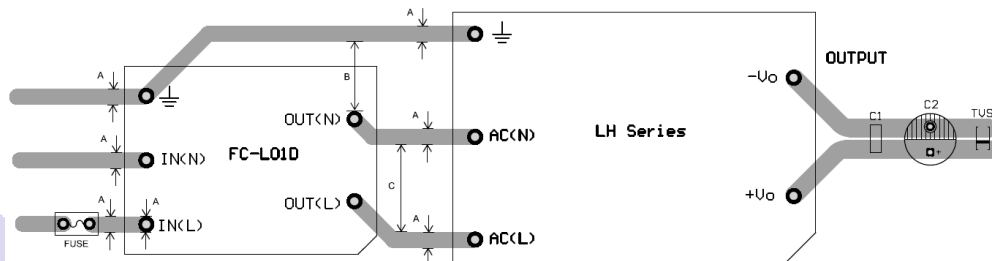

(figure 7): EMC application circuit PCB layout  
Safety and recommend wiring: linewidth  $A \geq 3\text{mm}$ ,  $B \geq 6\text{mm}$ ,  $C \geq 9\text{mm}$

EXTERNAL CIRCUIT PARAMETERS						
Model	C2( $\mu\text{F}$ )	C4( $\mu\text{F}$ )	C6( $\mu\text{F}$ )	TVS1	TVS2	TVS3
LH05-10B03	330			SMBJ7.0A		
LH05-10B05	330			SMBJ7.0A		
LH05-10B09	120			SMBJ12A		
LH05-10B12	120			SMBJ20A		
LH05-10B15	68			SMBJ20A		
LH05-10B24	68			SMBJ30A		
LH05-10A05	120	120		SMBJ7.0A	SMBJ7.0A	
LH05-10A12	68	68		SMBJ20A	SMBJ20A	
LH05-10A15	47	47		SMBJ20A	SMBJ20A	
LH05-10A24	10	10		SMBJ30A	SMBJ30A	
LH05-10C0505-01	220	22	22	SMBJ7.0A	SMBJ7.0A	SMBJ7.0A
LH05-10C0512-01	120	22	22	SMBJ7.0A	SMBJ20A	SMBJ20A
LH05-10C0515-01	120	22	22	SMBJ7.0A	SMBJ20A	SMBJ20A
LH05-10C0524-01	120	22	22	SMBJ7.0A	SMBJ30A	SMBJ30A
LH05-10D0505-01	220	22		SMBJ7.0A	SMBJ7.0A	
LH05-10D0512-01	220	22		SMBJ7.0A	SMBJ20A	

LH05-10D0515-01	120	22		SMBJ7.0A	SMBJ20A	
LH05-10D0524-01	120	22		SMBJ7.0A	SMBJ30A	
LH10-10B03	470			SMBJ7.0A		
LH10-10B05	330			SMBJ7.0A		
LH10-10B09	120			SMBJ12A		
LH10-10B12	120			SMBJ20A		
LH10-10B15	120			SMBJ20A		
LH10-10B24	68			SMBJ30A		
LH10-10A05	220	220		SMBJ7.0A	SMBJ7.0A	
LH10-10A12	120	120		SMBJ20A	SMBJ20A	
LH10-10A15	47	47		SMBJ20A	SMBJ20A	
LH10-10A24	33	33		SMBJ30A	SMBJ30A	
LH10-10C0512-02	220	68	68	SMBJ7.0A	SMBJ20A	SMBJ20A
LH10-10C0515-02	220	47	47	SMBJ7.0A	SMBJ20A	SMBJ20A
LH10-10D0505-02	220	68		SMBJ7.0A	SMBJ7.0A	
LH10-10D0512-02	220	68		SMBJ7.0A	SMBJ20A	
LH10-10D0515-02	220	47		SMBJ7.0A	SMBJ20A	
LH10-10D0524-02	220	47		SMBJ7.0A	SMBJ30A	
LH15-10B03	680			SMBJ7.0A		
LH15-10B05	680			SMBJ7.0A		
LH15-10B09	470			SMBJ12A		
LH15-10B12	220			SMBJ20A		
LH15-10B15	220			SMBJ20A		
LH15-10B24	68			SMBJ30A		
LH15-10B48	33			SMBJ64A		
LH15-10A05	470	470		SMBJ7.0A	SMBJ7.0A	
LH15-10A12	220	220		SMBJ20A	SMBJ20A	
LH15-10A15	120	120		SMBJ20A	SMBJ20A	
LH15-10C0505-05	470	220	220	SMBJ7.0A	SMBJ7.0A	SMBJ7.0A
LH15-10C0512-02	470	120	120	SMBJ7.0A	SMBJ20A	SMBJ20A
LH15-10C0515-02	470	120	120	SMBJ7.0A	SMBJ20A	SMBJ20A
LH15-10C0524-01	470	120	120	SMBJ7.0A	SMBJ30A	SMBJ30A
LH15-10D0505-08	470	470		SMBJ7.0A	SMBJ7.0A	
LH15-10D0512-04	470	220		SMBJ7.0A	SMBJ20A	
LH15-10D0515-03	470	120		SMBJ7.0A	SMBJ20A	
LH15-10D0524-02	470	47		SMBJ7.0A	SMBJ30A	
LH20-10B03	330			SMBJ7.0A		
LH20-10B05	330			SMBJ7.0A		
LH20-10B09	220			SMBJ12A		
LH20-10B12	220			SMBJ20A		
LH20-10B15	220			SMBJ20A		
LH20-10B24	220			SMBJ30A		
LH20-10A05	470	470		SMBJ7.0A	SMBJ7.0A	
LH20-10A12	120	120		SMBJ20A	SMBJ20A	
LH20-10A15	68	68		SMBJ20A	SMBJ20A	
LH20-10C0505-05	330	120	120	SMBJ7.0A	SMBJ7.0A	SMBJ7.0A
LH20-10C0512-04	330	120	120	SMBJ7.0A	SMBJ20A	SMBJ20A
LH20-10C0515-03	330	120	120	SMBJ7.0A	SMBJ20A	SMBJ20A
LH20-10C0524-02	330	47	47	SMBJ7.0A	SMBJ30A	SMBJ30A
LH20-10D0512-06	330	220		SMBJ7.0A	SMBJ20A	
LH20-10D0515-05	330	220		SMBJ7.0A	SMBJ20A	
LH20-10D0524-03	330	120		SMBJ7.0A	SMBJ30A	
LH25-10B03	330			SMBJ7.0A		
LH25-10B05	330			SMBJ7.0A		
LH25-10B09	330			SMBJ12A		
LH25-10B12	330			SMBJ20A		
LH25-10B15	330			SMBJ20A		
LH25-10B24	120			SMBJ30A		
LH25-10B48	68			SMBJ64A		

Note:

- Output filtering capacitors C2, C4 and C6 are electrolytic capacitors, It is recommended to use high frequency and low impedance electrolytic capacitors. For capacitance and current of capacitor please refer to manufacture's datasheet. Voltage derating of capacitor should be 80% or above. C1,C3,C5 are use to filter high frequency noise, suggest choose 1 $\mu$ F. TVS is recommended component to protect post-circuits (if converter fails). External input NTC is recommended to use 5D-9.
- For standard EMC requirement, please refer to figure 1, figure 2, figure 3 or figure 4. If higher EMC requirement, please refer to figure 6, recommended parameters are shown in the table below.

Recommend Parameter For Higher EMC Standard Circuit	
Components	Recommend Parameter
MOV	S14K350
R1	2 $\Omega$ /3W
R2	2 $\Omega$ /3W
R3	1M $\Omega$ /2W
CY1	1nF/400VAC
CY2	1nF/400VAC
CY3	1nF/400VAC
CY4	1nF/400VAC
CX	0.22 $\mu$ F/275VAC
FC-L01D	2KV/4KV EMC Filter
LCM	10mH, recommended to use MORNSUN's FL2D-Z5-103
FUSE	1A/250V(LH05) , slow blow, it must be connected to FUSE
	2A/250V(LH10/LH15) , slow blow, it must be connected to FUSE
	3.15A/250V(LH20/LH25) , slow blow, it must be connected to FUSE

## LHXX PCB MOUNTING OUTLINE DIMENSIONS,RECOMMENDED FOOTPRINT

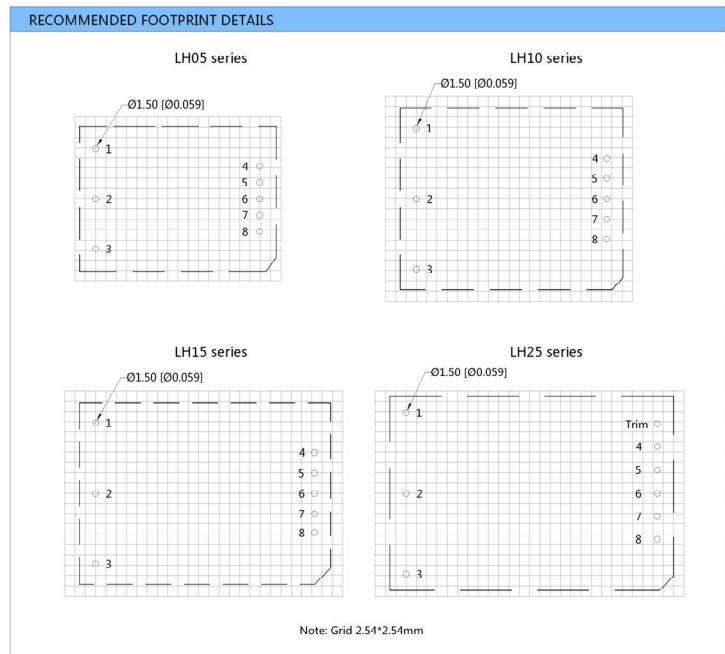
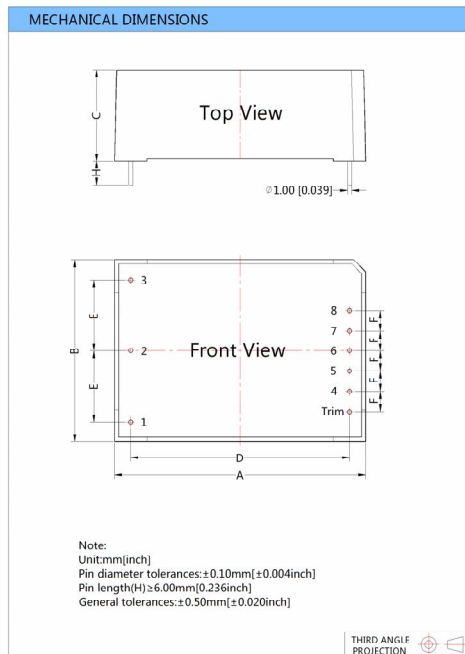

DIMENSIONS (Unit: mm)					
NO.	LH05	LH10	LH15	LH20	LH25
A	48.50	55.00	62.00	70.00	70.00
B	36.00	45.00	45.00	48.00	48.00
C	20.50	21.00	22.50	23.50	23.50
D	40.50	47.00	54.00	62.00	62.00
E	12.50	17.50	17.50	20.00	20.00
F	4.00	5.00	5.00	5.75	5.75
G	10.00	12.50	12.50	12.50	12.50

MODELS WEIGHT					
WEIGHT	LH05	LH10	LH15	LH20	LH25
(Typ.)	50g	80g	85g	120g	120g

Pin CONNECTION				
Pin	LHXX-10B	LHXX-10A	LHXX-10C	LHXX-10D
1				
2	AC(N)	AC(N)	AC(N)	AC(N)
3	AC(L)	AC(L)	AC(L)	AC(L)
4	-Vo	-Vo	-Vo1	-Vo1
5	No Pin	No Pin	+Vo1	+Vo1
6	No Pin	COM	-Vo2	No Pin
7	No Pin	No Pin	COM	-Vo2
8	+Vo	+Vo	+Vo2	+Vo2
Trim	Trim**	No Pin	No Pin	No Pin

There is no pin "1" on LH15-10BXX  
Trim\*\*: only for LH20/25-10BXX Series.



## LHXXA2 CHASSIS MOUNTING OUTLINE DIMENSIONS



### MECHANICAL DIMENSIONS

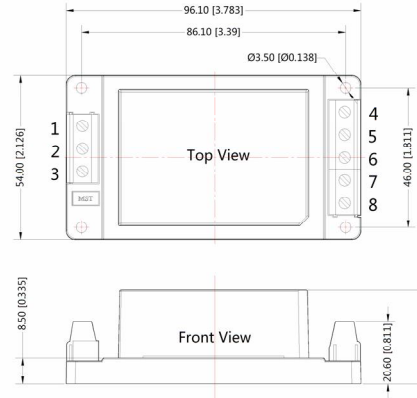

Note:  
Unit:mm[inch]  
Wire range : 24~12 AWG  
General tolerances:±0.50[±0.020]

THIRD ANGLE PROJECTION

\*The figure above is related to LH15XXA2 series, the height of other series is different.

DIMENSIONS (Unit: mm)	
MODEL	DIMENSIONS
LH05XXA2	96.1x54x29mm
LH10XXA2	96.1x54x29.5mm
LH15XXA2	96.1x54x31mm
LH20XXA2	96.1x54x32mm
LH25XXA2	96.1x54x32mm

MODELS WEIGHT					
WEIGHT	LH05	LH10	LH15	LH20	LH25
Typ.	100g	130g	135g	170g	170g

FOOTPRINT CONNECTION				
Pin	LHXX-10B	LHXX-10A	LHXX-10C	LHXX-10D
1				
2	AC(N)	AC(N)	AC(N)	AC(N)
3	AC(L)	AC(L)	AC(L)	AC(L)
4	-Vo	-Vo	-Vo1	-Vo1
5	NC	NC	+Vo1	+Vo1
6	NC/Trim**	COM	-Vo2	NC
7	NC	NC	COM	-Vo2
8	+Vo	+Vo	+Vo2	+Vo2

There is no pin "1" on LH15-10BXXA2.  
NC/Trim\*\* : The pin is Trim on LH20/25-10BXXA2 ,  
The pin is not connected on other single output products.

## LHXXA3 CHASSIS MOUNTING OUTLINE DIMENSIONS



### MECHANICAL DIMENSIONS

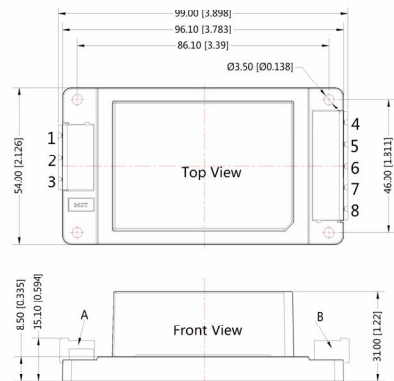

Note:  
Unit:mm[inch]  
Wire range : 24~12 AWG  
General tolerances:±0.50[±0.020]  
A:DEGSON P/N: 2EDGRC-7.5-03P-14-100A ( H )  
B: DEGSON P/N: 2EDGRC-7.5-05P-14-100A ( H )

THIRD ANGLE PROJECTION

OUTLINE AND DIMENSIONS (Unit: mm)	
MODEL	DIMENSIONS
LH05XXA3	99x54x29mm
LH10XXA3	99x54x29.5mm
LH15XXA3	99x54x31mm
LH20XXA3	99x54x32mm
LH25XXA3	99x54x32mm

MODELS WEIGHT					
WEIGHT	LH05	LH10	LH15	LH20	LH25
Typ.	100g	130g	135g	170g	170g

\*The figure above is related to LH15XXA3 series, the height of other series is different.

\*\*Footprint Details are the same as A2 Chassis mounting with A3 Chassis mounting

# LHXXA4 DIN-RAIL MOUNTING OUTLINE DIMENSIONS



DIN35mm standard rail installation

DIMENSIONS (Unit: mm)					
MODEL	DIMENSIONS				
LH05XXA4	96.1x54x33.6mm				
LH10XXA4	96.1x54x34.1mm				
LH15XXA4	96.1x54x35.6mm				
LH20XXA4	96.1x54x36.6mm				
LH25XXA4	96.1x54x36.6mm				
MODELS WEIGHT					
WEIGHT	LH05	LH10	LH15	LH20	LH25
Typ.	140g	170g	175g	210g	210g

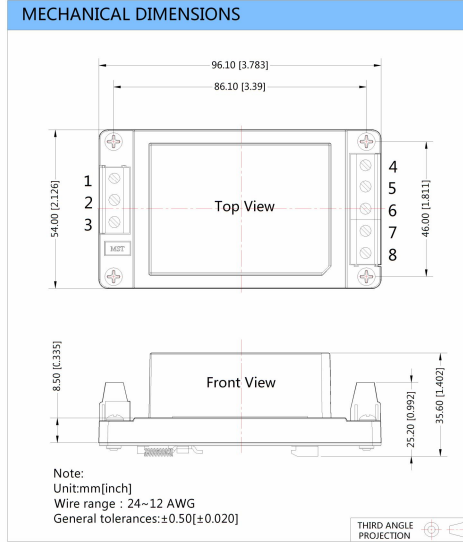

\* The figure above is related to LH15 series, the height of other series is different.

\*\*Footprint Details are the same as Chassis mounting with Screw Terminals.

## PACKAGE DIAGRAM

PCB mounting Series(LH05 series)

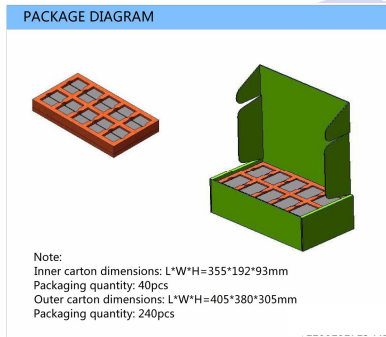

PCB mounting Series (Other series)

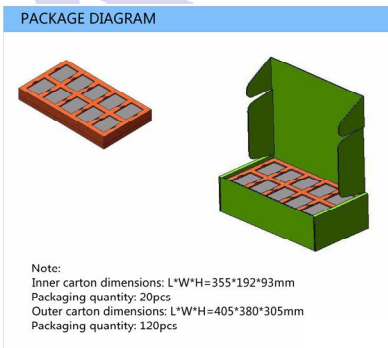

Special Package Series (A2S/A4S)

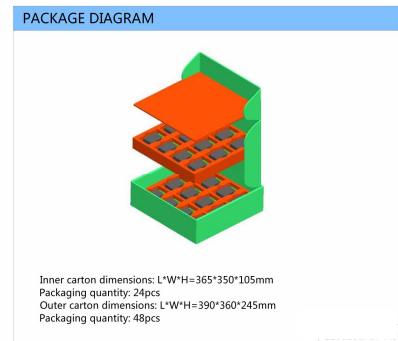

### MORSUN Science & Technology Co.,Ltd.

Address: No. 5, Kehui St. 1, Kehui development center, Science Ave., Guangzhou Science City, Luogang district, Guangzhou,P.R.China.

Tel: 86-20-38601850

Fax:86-20-38601272

E-mail: [info@mornsun.cn](mailto:info@mornsun.cn)

[Http://www.mornsun-power.com](http://www.mornsun-power.com)