

Reflective Interrupter

Version 1.5

SFH 9206

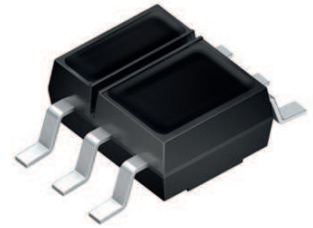

Features:

- 940nm emitter in combination with a silicon NPN phototransistor
- Optimal operating distance 1 mm to 5 mm
- Daylight cut-off filter
- Emitter and detector electrically isolated
- Soldering Methode: IR Reflow Soldering
- Product complies to MSL Level 4

Applications

- Position reporting
- End position switch
- Speed monitoring and regulating
- Motion transmitter

Ordering Information

Type:	Collector-emitter current I_{PCE} [μ A] Kodak neutral white testcard with 90% reflection; $I_F = 10$ mA, $V_{CE} = 5$ V, $d = 1$ mm	Ordering Code
SFH 9206	160 ... 2000	Q65111A3179
SFH 9206-4	160 ... 320	-
SFH 9206-5/6	250 ... 800	Q65111A3177
SFH 9206-6/7	400 ... 1250	Q65111A3178
SFH 9206-8	1000 ... 2000	-

Maximum Ratings ($T_A = 25\text{ °C}$)

Parameter	Symbol	Values	Unit
Emitter			
Reverse voltage	V_R	5	V
Forward current	I_F	50	mA
Surge current ($t_p \leq 10\ \mu\text{s}$, $D=0$)	I_{FSM}	0.7	A
Power consumption	P_{tot}	100	mW
Thermal resistance junction - ambient ^{1) page 14}	R_{thJA}	495	K / W

Detector

Collector-emitter voltage	V_{CE}	16	V
Collector-emitter voltage ($t \leq 2\ \text{min}$)	V_{CE}	30	V
Emitter-collector voltage	V_{EC}	7	V
Collector current	I_C	10	mA
Total Power dissipation	P_{tot}	100	mW
Thermal resistance junction - ambient ^{1) page 14}	R_{thJA}	495	K / W

Interrupter

Operating and storage temperature range	T_{op} ; T_{stg}	-40 ... 100	°C
Ambient temperature range	T_A	-40 ... 100	°C
Total power dissipation	P_{tot}	150	mW
Electrostatic discharge	V_{ESD}	2	kV

Characteristics ($T_A = 25\text{ °C}$)

Parameter	Symbol	Values	Unit
Emitter			
Peak wavelength ($I_F = 50\ \text{mA}$, $t_p = 20\ \text{ms}$)	(typ) λ_{peak}	950	nm
Forward voltage ($I_F = 50\ \text{mA}$, $t_p = 20\ \text{ms}$)	(typ (max)) V_F	1.45 (≤ 1.8)	V
Reverse current ($V_R = 5\ \text{V}$)	I_R	not designed for reverse operation	μA

Detector

Parameter		Symbol	Values	Unit
Capacitance ($V_{CE} = 0\text{ V}$, $f = 1\text{ MHz}$, $E = 0$)	(typ)	C_{CE}	5	pF
Dark current ($V_{CE} = 16\text{ V}$, $E = 0$)	(typ (max))	I_{CE0}	1 (≤ 50)	nA
Photocurrent (ambient light sensitivity) ($V_{CE} = 5\text{ V}$, $E_V = 1000\text{ lx}$)	(typ)	I_{PCE}	1	mA

Interrupter

Collector-emitter current (Kodak neutral white testcard with 90% reflection; $I_F = 10\text{ mA}$, $V_{CE} = 5\text{ V}$, $d = 1\text{ mm}$)	(min)	I_{PCE}	160	μA
	(typ)	I_{PCE}	600	μA
	(max)	I_{PCE}	2000	μA
Collector-emitter saturation voltage (Kodak neutral white testcard with 90% reflection; $I_F = 10\text{ mA}$, $I_C = 55\text{ }\mu\text{A}$, $d = 1\text{ mm}$)	(typ (max))	V_{CEsat}	200 (< 600)	mV

Switching Times

Turn-on time ^{2) page 14} ($V_{CC} = 5\text{ V}$, $I_C = 100\text{ }\mu\text{A}$, $R_L = 1\text{ k}\Omega$)	(typ)	t_{on}	40	μs
Rise time ^{2) page 14} ($V_{CC} = 5\text{ V}$, $I_C = 100\text{ }\mu\text{A}$, $R_L = 1\text{ k}\Omega$)	(typ)	t_r	30	μs
Turn-off time ^{2) page 14} ($V_{CC} = 5\text{ V}$, $I_C = 100\text{ }\mu\text{A}$, $R_L = 1\text{ k}\Omega$)	(typ)	t_{off}	45	μs
Fall time ^{2) page 14} ($V_{CC} = 5\text{ V}$, $I_C = 100\text{ }\mu\text{A}$, $R_L = 1\text{ k}\Omega$)	(typ)	t_f	40	μs

Mechanical test setup

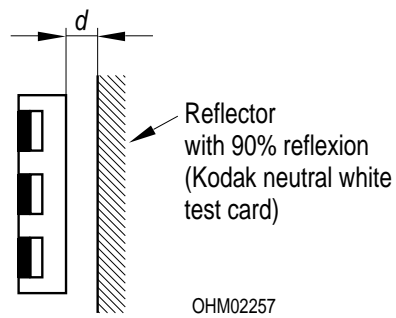

Test Circuit for Switching and Response Time

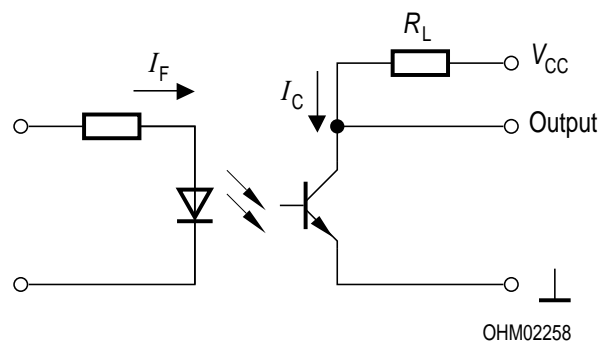

Collector Current ^{3) page 14}

$I_C / I_{Cmax} = f(d), T_A = 25^\circ C$

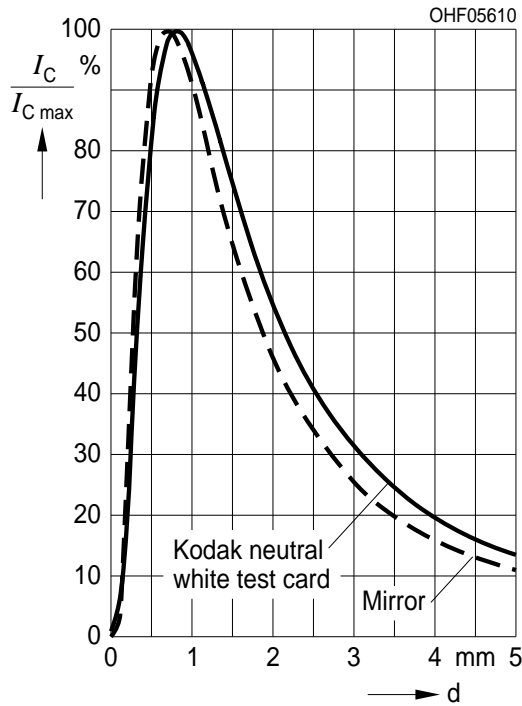

Collector Current ^{3) page 14}

$I_C = f(I_F), d = 1 \text{ mm}, 90\% \text{ reflection}, T_A = 25^\circ C$

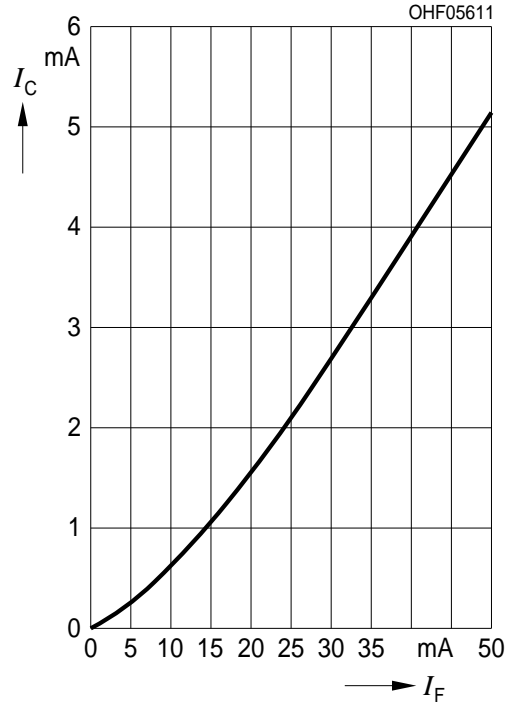

Photocurrent ^{3) page 14}

$I_C = f(V_{CE}), d = 1 \text{ mm}, 90\% \text{ reflection}, T_A = 25^\circ C$

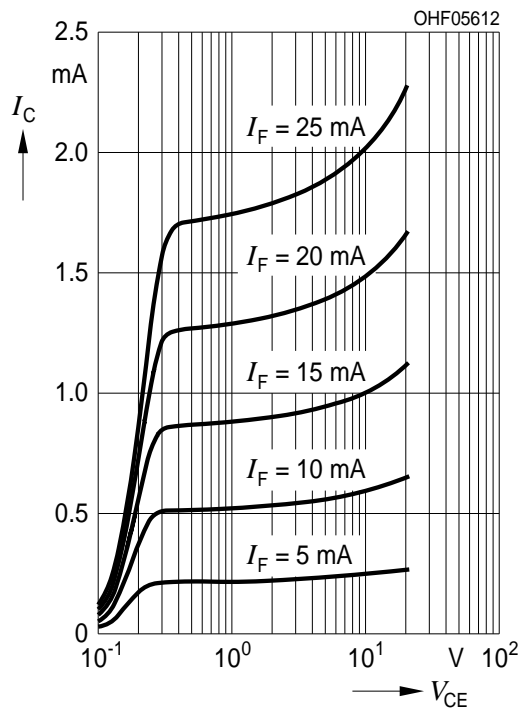

Relative Spectral Emission ^{3) page 14}

(typ) $I_{rel} = f(\lambda), T_A = 25^\circ C$

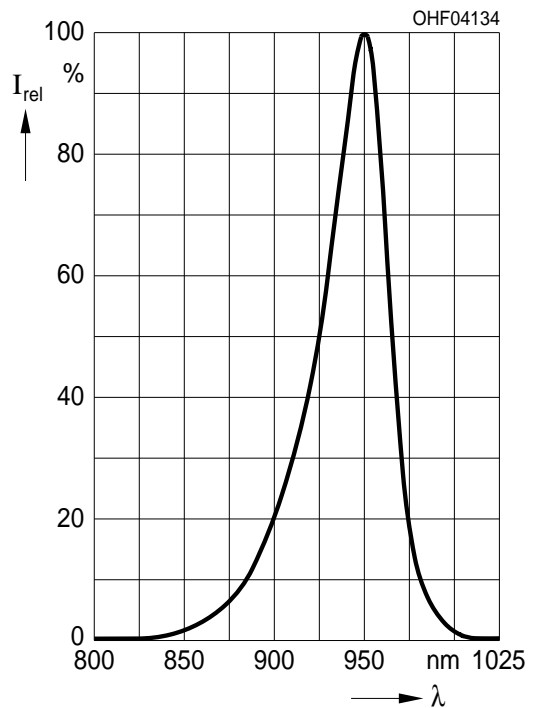

Forward Current ^{3) page 14}

$I_F = f(V_F)$, single pulse, $t_p = 100 \mu s$

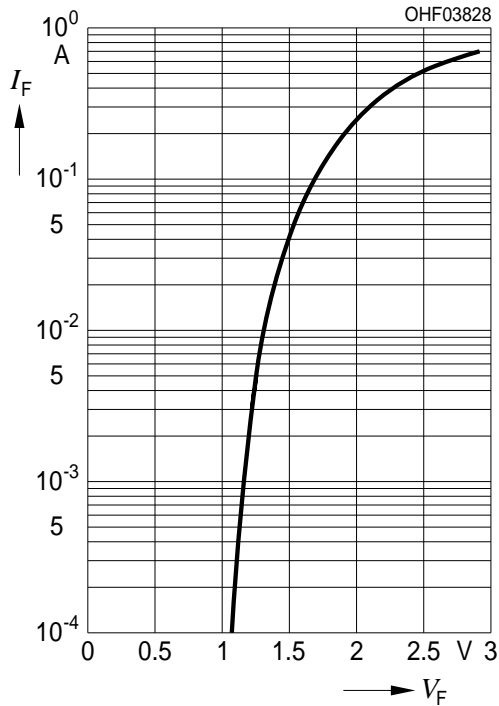

Max. Permissible Forward Current

$I_F = f(T_A)$

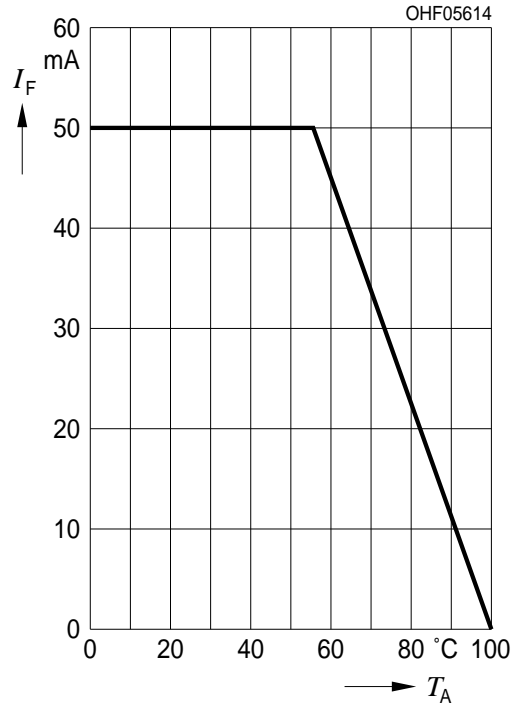

Permissible Pulse Handling Capability

$I_F = f(t_p)$, $T_A = 25 \text{ °C}$, duty cycle $D = \text{parameter}$

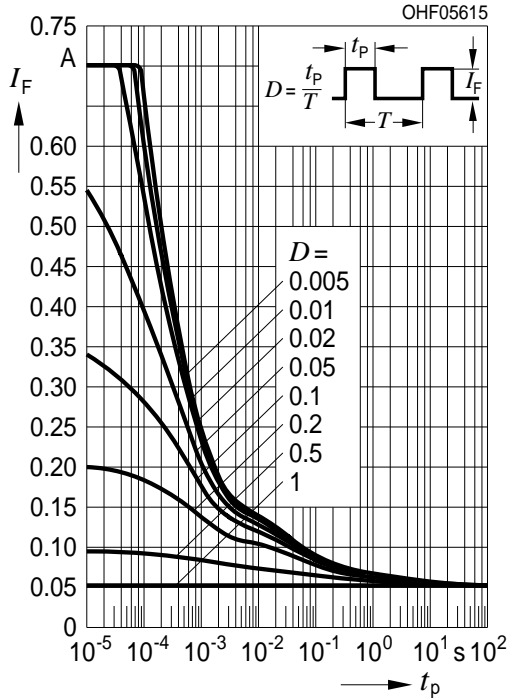

Permissible Pulse Handling Capability

$I_F = f(t_p)$, $T_A = 85 \text{ °C}$, duty cycle $D = \text{parameter}$

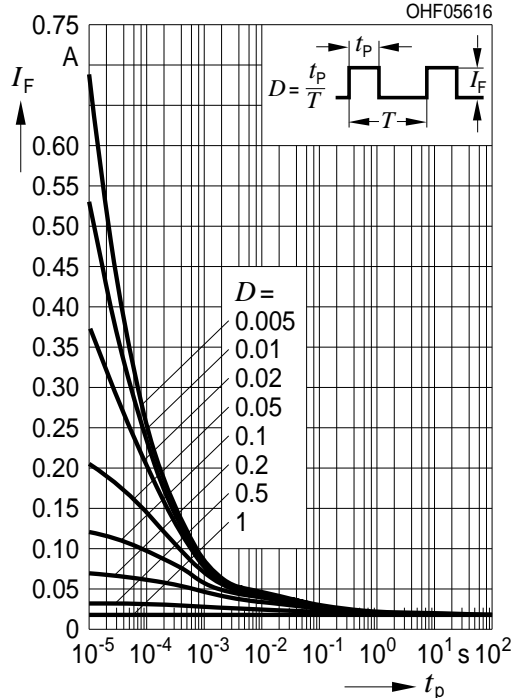

Dark Current ^{3) page 14}

$I_{CEO} = f(T_A), V_{CE} = 20 \text{ V}, E = 0$

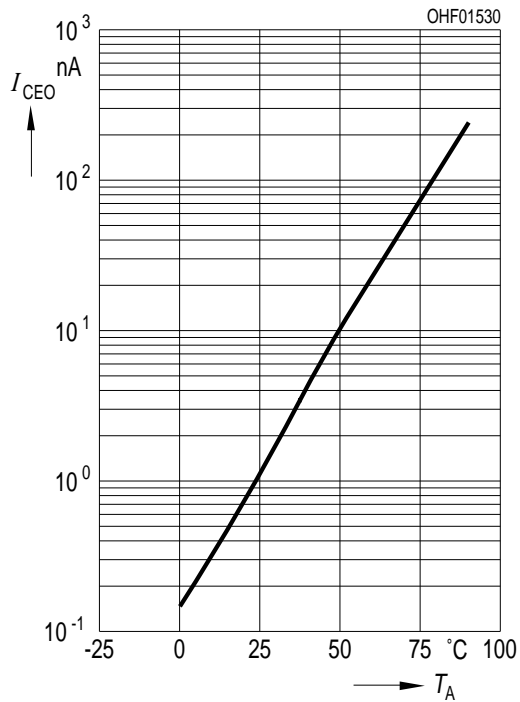

Collector-Emitter Capacitance ^{3) page 14}

$C_{CE} = f(V_{CE}), f = 1 \text{ MHz}, E = 0, T_A = 25^\circ\text{C}$

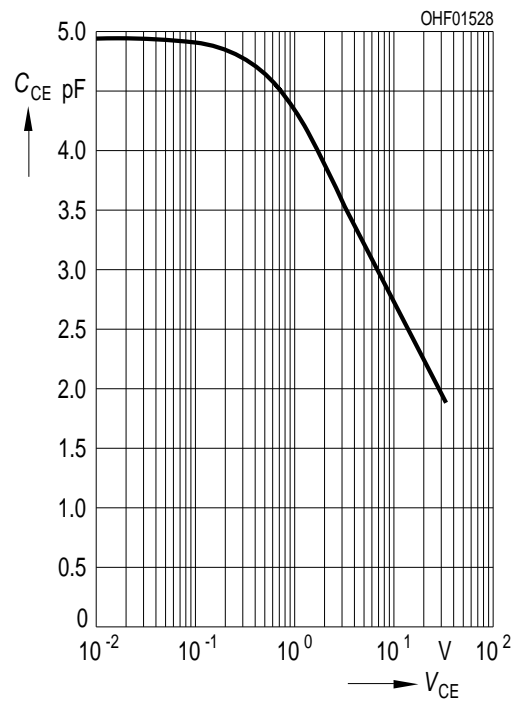

Relative Spectral Sensitivity ^{3) page 14}

$S_{rel} = f(\lambda), T_A = 25^\circ\text{C}$

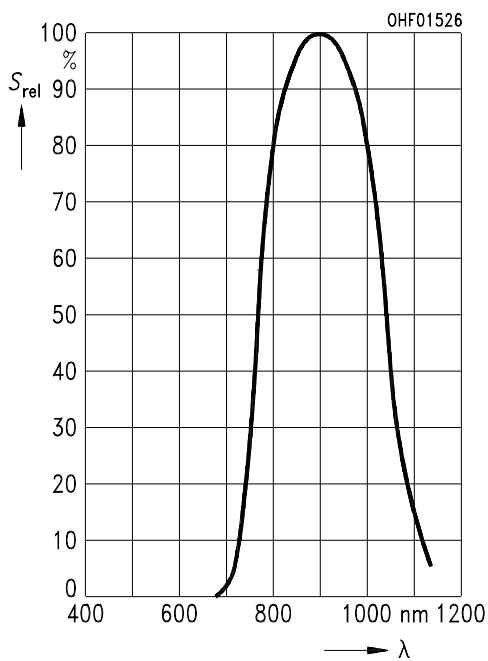

Photocurrent ^{3) page 14}

$I_{PCE} / I_{PCE}(25^\circ\text{C}) = f(T_A), V_{CE} = 5 \text{ V}, I_f = 10 \text{ mA}$

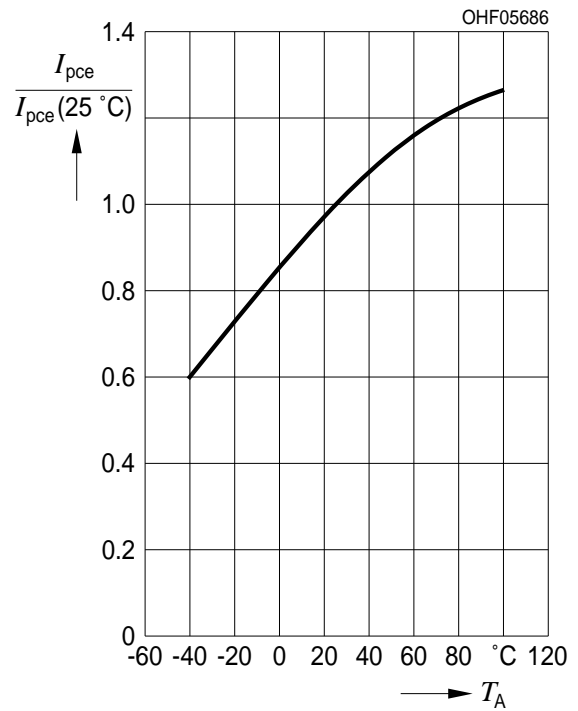

Package Outline

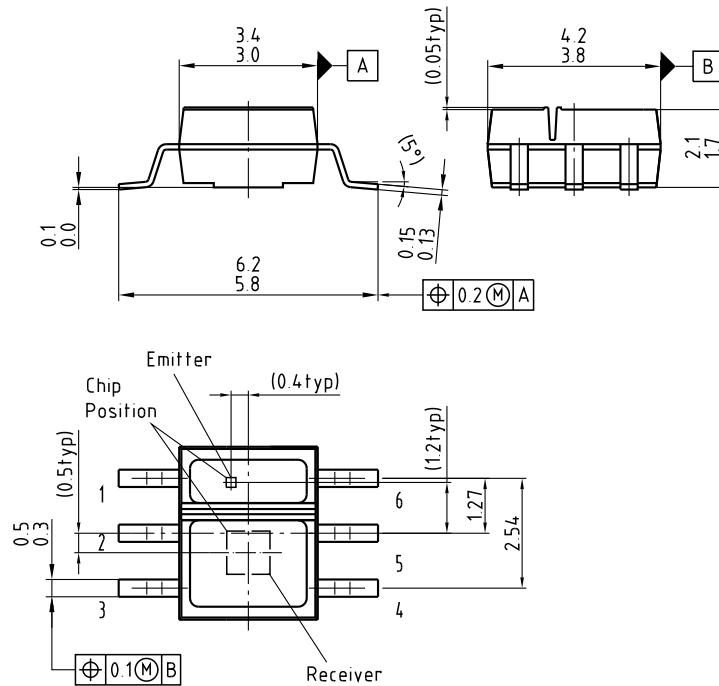

C63062-A3059-A11 -01

Dimensions in mm.

Pinning

Pin	Description
1	Anode
2	-
3	Emitter
4	Collector
5	-
6	Cathode

Package

Reflective Interrupter

Approximate Weight:

40.0 mg

Recommended Solder Pad

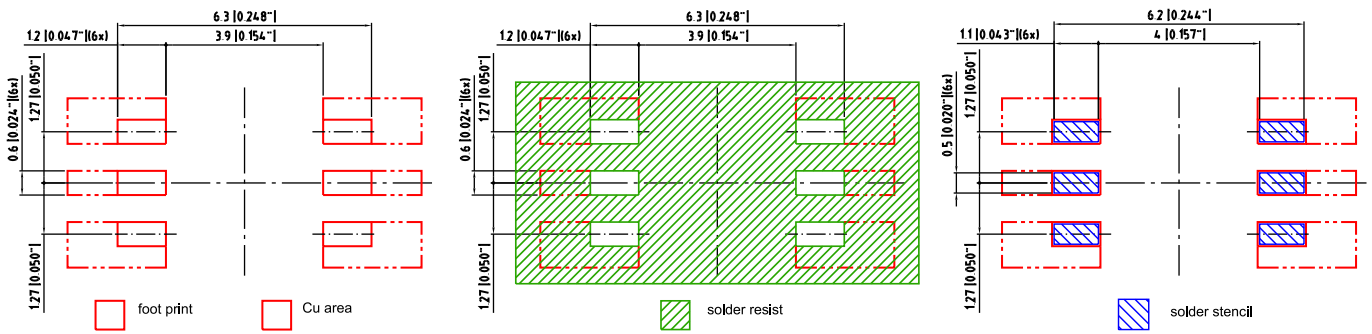

Component Location on Pad

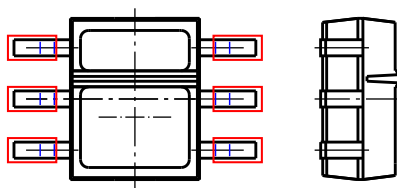

E062.3010.158 -01

Dimensions in mm (inch).

Reflow Soldering Profile

Product complies to MSL Level 4 acc. to JEDEC J-STD-020D.01

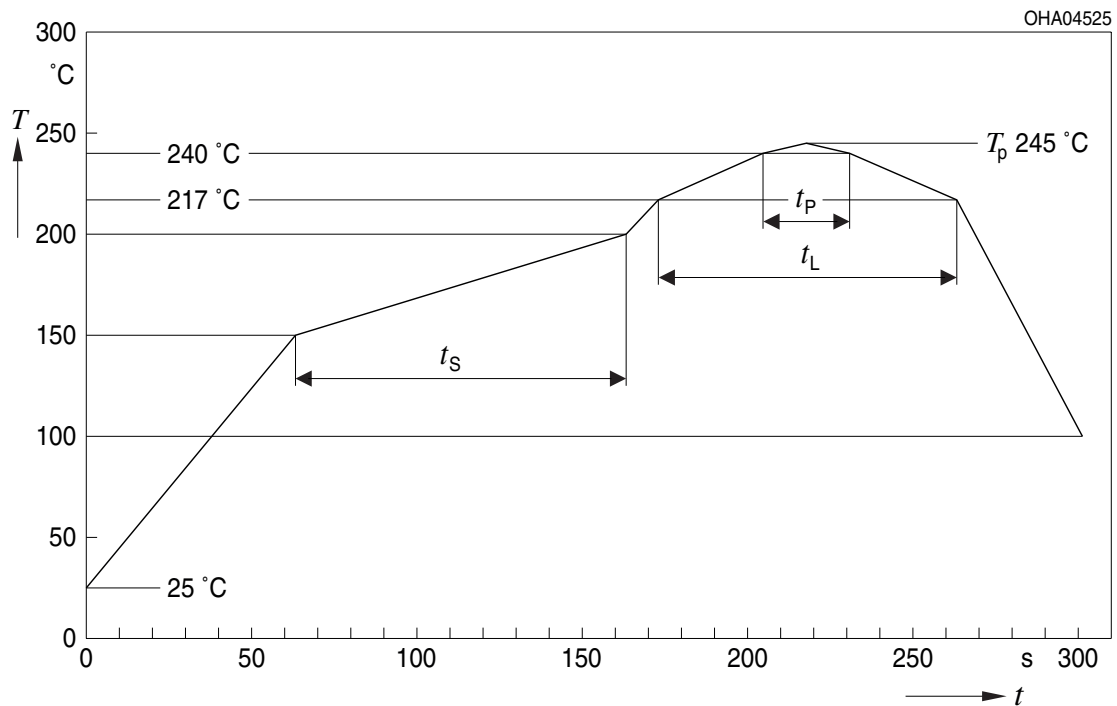

OHA04612

Profile Feature Profil-Charakteristik	Symbol Symbol	Pb-Free (SnAgCu) Assembly			Unit Einheit
		Minimum	Recommendation	Maximum	
Ramp-up rate to preheat*) 25 °C to 150 °C			2	3	K/s
Time t_S T_{Smin} to T_{Smax}	t_S	60	100	120	s
Ramp-up rate to peak*) T_{Smax} to T_P			2	3	K/s
Liquidus temperature	T_L		217		°C
Time above liquidus temperature	t_L		80	100	s
Peak temperature	T_P		245	260	°C
Time within 5 °C of the specified peak temperature $T_P - 5$ K	t_P	10	20	30	s
Ramp-down rate* T_P to 100 °C			3	6	K/s
Time 25 °C to T_P				480	s

All temperatures refer to the center of the package, measured on the top of the component

* slope calculation DT/Dt : Dt max. 5 s; fulfillment for the whole T-range

Taping

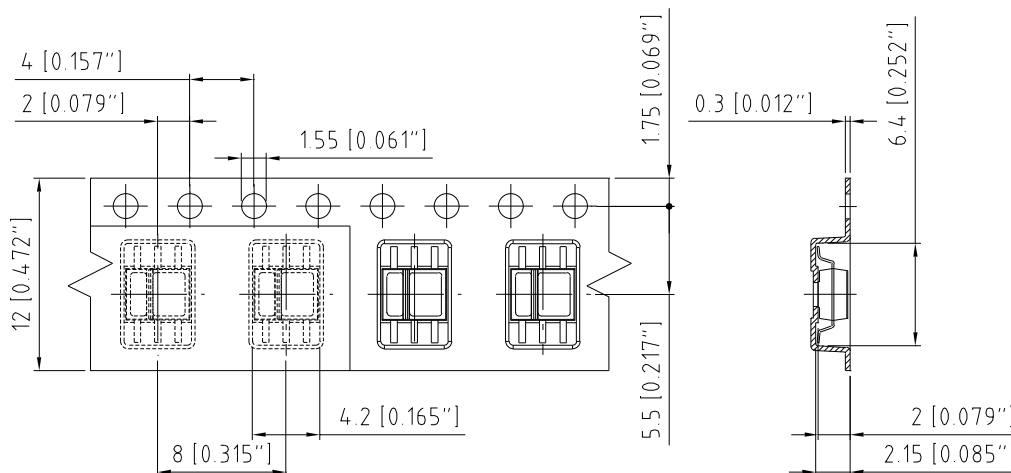

C63062-A3059-B10-03

Dimensions in mm (inch).

Tape and Reel

12 mm tape with 1000 pcs. on \varnothing 180 mm reel

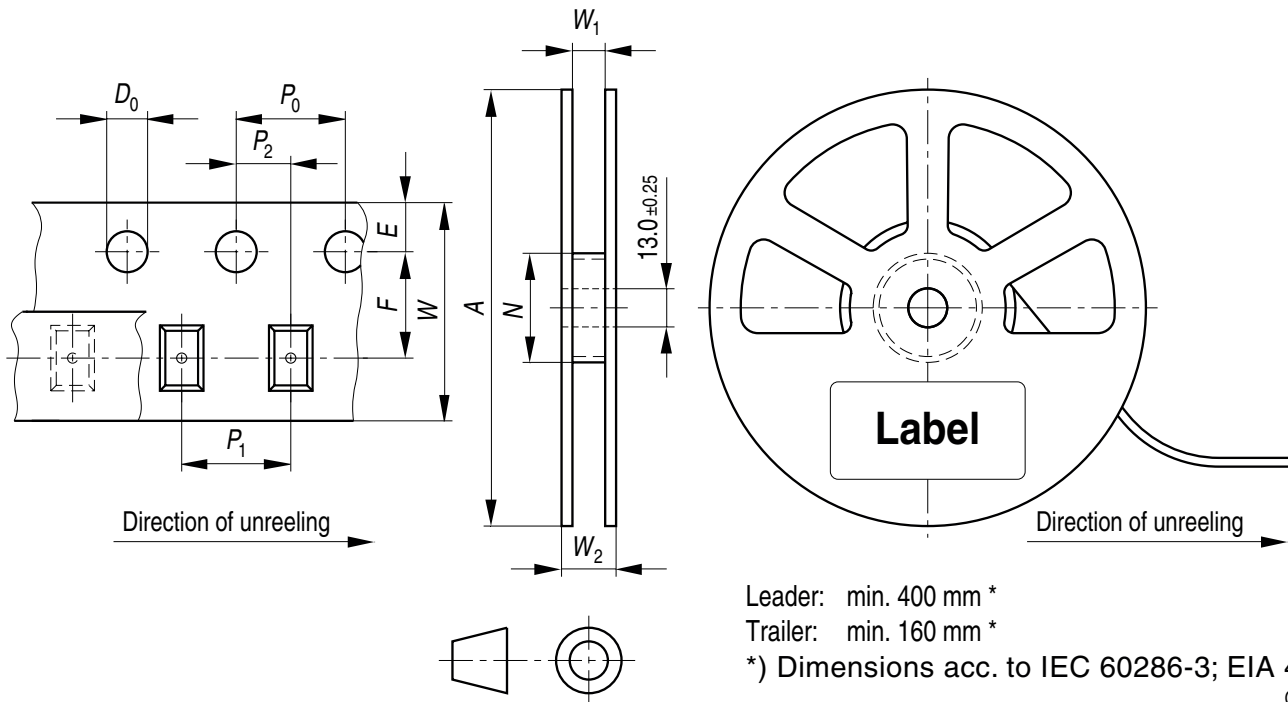

Leader: min. 400 mm *

Trailer: min. 160 mm *

*) Dimensions acc. to IEC 60286-3; EIA 481-D

OHAY0324

Tape dimensions [mm]

W	P ₀	P ₁	P ₂	D ₀	E	F
12 + 0.3 / - 0.1	4 ± 0.1	4 ± 0.1 or 8 ± 0.1	2 ± 0.05	1.5 ± 0.1	1.75 ± 0.1	5.5 ± 0.05

Reel dimensions [mm]

A	W	N _{min}	W ₁	W _{2max}
180	12	60	12.4 + 2	18.4

Barcode-Product-Label (BPL)

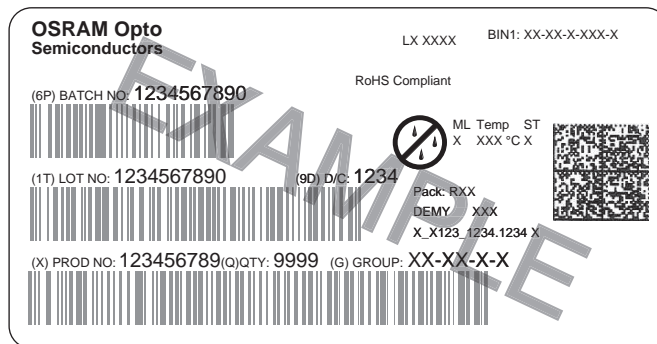

OHA04563

Dry Packing Process and Materials

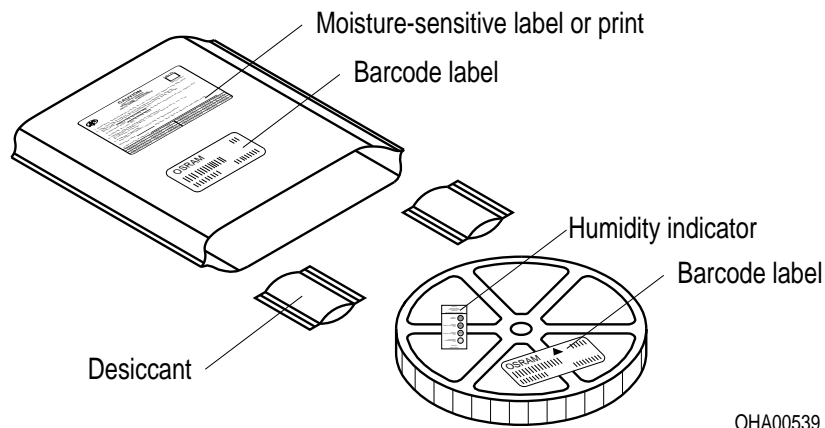

OHA00539

Note:

Moisture-sensitive product is packed in a dry bag containing desiccant and a humidity card. Regarding dry pack you will find further information in the internet. Here you will also find the normative references like JEDEC.

Transportation Packing and Materials

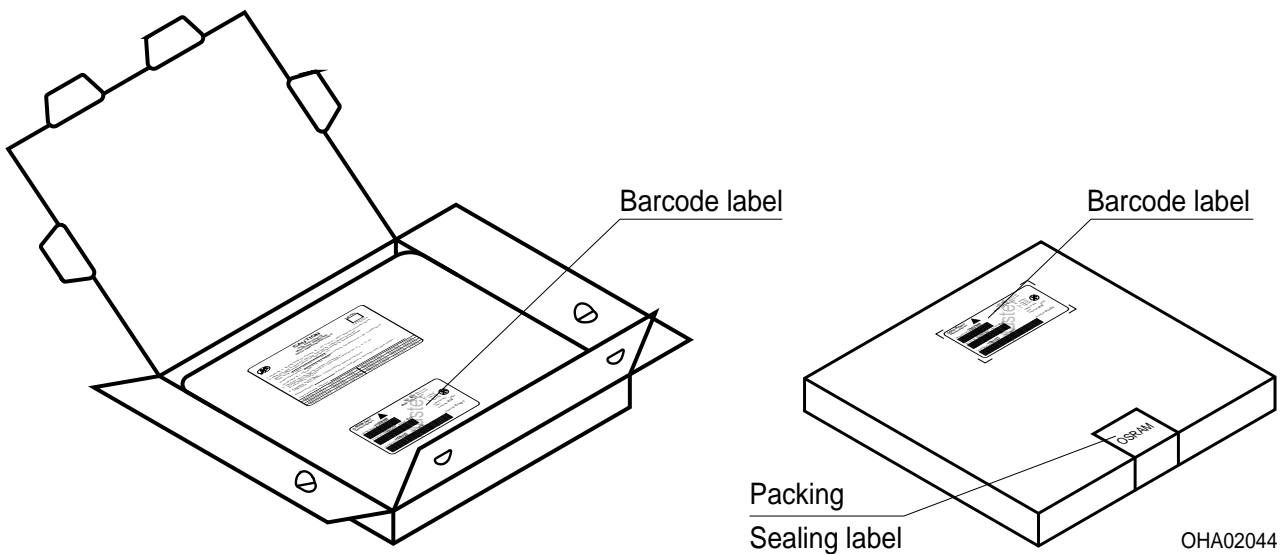

OHA02044

Dimensions of transportation box in mm

Width	Length	Height
195 ± 5	195 ± 5	30 ± 5

Disclaimer

Language english will prevail in case of any discrepancies or deviations between the two language wordings.

Attention please!

The information describes the type of component and shall not be considered as assured characteristics.

Terms of delivery and rights to change design reserved. Due to technical requirements components may contain dangerous substances.

For information on the types in question please contact our Sales Organization.

If printed or downloaded, please find the latest version in the Internet.

Packing

Please use the recycling operators known to you. We can also help you – get in touch with your nearest sales office.

By agreement we will take packing material back, if it is sorted. You must bear the costs of transport. For packing material that is returned to us unsorted or which we are not obliged to accept, we shall have to invoice you for any costs incurred.

Components used in life-support devices or systems must be expressly authorized for such purpose!

Critical components* may only be used in life-support devices** or systems with the express written approval of OSRAM OS.

*) A critical component is a component used in a life-support device or system whose failure can reasonably be expected to cause the failure of that life-support device or system, or to affect its safety or the effectiveness of that device or system.

**) Life support devices or systems are intended (a) to be implanted in the human body, or (b) to support and/or maintain and sustain human life. If they fail, it is reasonable to assume that the health and the life of the user may be endangered.

Glossary

- 1) **Thermal resistance:** Mounting on PC-board with $> 5 \text{ mm}^2$ pad size
- 2) I_C as a function of the forward current of the emitting diode, the degree of reflection and the distance between reflector and component (d)
- 3) **Typical Values:** Due to the special conditions of the manufacturing processes of LED, the typical data or calculated correlations of technical parameters can only reflect statistical figures. These do not necessarily correspond to the actual parameters of each single product, which could differ from the typical data and calculated correlations or the typical characteristic line. If requested, e.g. because of technical improvements, these typ. data will be changed without any further notice.

Published by OSRAM Opto Semiconductors GmbH
Leibnizstraße 4, D-93055 Regensburg
www.osram-os.com © All Rights Reserved.

EU RoHS and China RoHS compliant product



此产品符合欧盟 RoHS 指令的要求；
按照中国的相关法规和标准，不含有毒有害物质或元素。