

Dimension:
Unit=mm

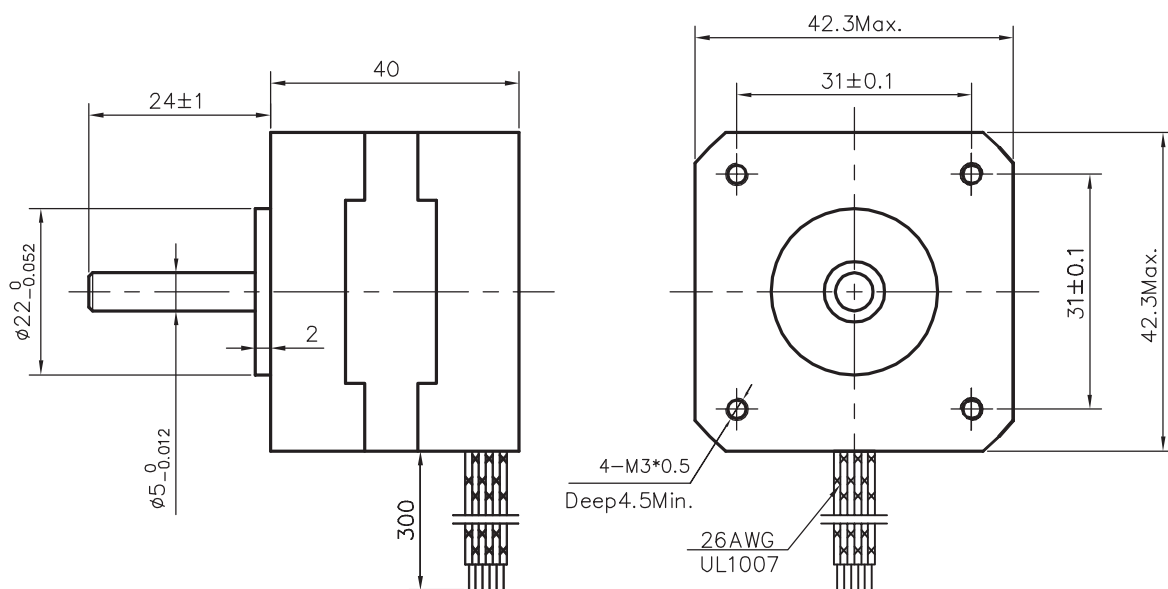

Specifications:

Phase	4		Comment
Step Angle	0.9	deg.	
Voltage	6.0	V	
Current	0.8	A	
Resistance	7.5	Ω	
Inductance	9.6	mH	
Holding Torque	2.6	kg.cm	
Insulation Class	B		
Mass	0.28	kg	

Wiring Diagram:

