



TYN210 ---> TYN1010

SCR

FEATURES

- High surge capability
- High on-state current
- High stability and reliability

DESCRIPTION

The TYN210 ---> TYN1010 Family of Silicon Controlled Rectifiers uses a high performance glass passivated technology.

This general purpose Family of Silicon Controlled Rectifiers is designed for power supplies up to 400Hz on resistive or inductive load.

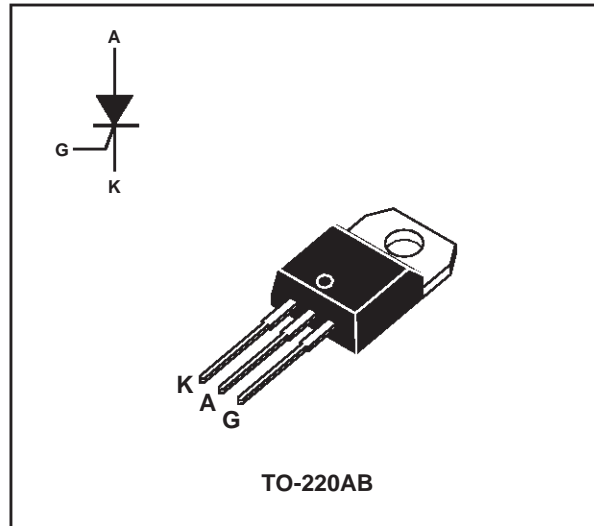

ABSOLUTE RATINGS (limiting values)

Symbol	Parameter	Value	Unit	
$I_{T(RMS)}$	RMS on-state current (180° conduction angle)	$T_c = 100^\circ\text{C}$ 10	A	
$I_{T(AV)}$	Average on-state current (180° conduction angle, single phase circuit)	$T_c = 100^\circ\text{C}$ 6.4	A	
I_{TSM}	Non repetitive surge peak on-state current (T_j initial = 25°C)	$t_p = 8.3\text{ms}$	105	A
		$t_p = 10\text{ms}$	100	
I^2t	I^2t value	$t_p = 10\text{ms}$ 50	A^2s	
di/dt	Critical rate of rise of on-state current Gate supply: $I_G = 100\text{mA}$ $di_G/dt = 1\text{A}/\mu\text{s}$	50	$\text{A}/\mu\text{s}$	
T_{stg} T_j	Storage and operating junction temperature range	-40 to +150 -40 to +125	$^\circ\text{C}$	
TI	Maximum lead soldering temperature during 10s at 4.5mm from case	260	$^\circ\text{C}$	

Symbol	Parameter	TYN					Unit
		210	410	610	810	1010	
V_{DRM} V_{RRM}	Repetitive peak off-state voltage $T_j = 125^\circ\text{C}$	200	400	600	800	1000	V

TYN210 ---> TYN1010

THERMAL RESISTANCE

Symbol	Parameter	Value	Unit
Rth (j-a)	Junction to ambient	60	°C/W
Rth (j-c) DC	Junction to case for DC	2.5	°C/W

GATE CHARACTERISTICS (maximum values)

$P_{G(AV)} = 1W$ $P_{GM} = 10W$ ($t_p = 20\mu s$) $I_{FGM} = 4A$ ($t_p = 20\mu s$) $V_{RGM} = 5V$

ELECTRICAL CHARACTERISTICS

Symbol	Test conditions	Value	Unit
I_{GT}	$V_D = 12V$ (DC) $R_L = 33\Omega$	$T_j = 25^\circ C$ MAX.	15 mA
V_{GT}	$V_D = 12V$ (DC) $R_L = 33\Omega$	$T_j = 25^\circ C$ MAX.	1.5 V
V_{GD}	$V_D = V_{DRM}$ $R_L = 3.3k\Omega$	$T_j = 110^\circ C$ MIN.	0.2 V
tgt	$V_D = V_{DRM}$ $I_G = 40mA$ $di_G/dt = 0.5A/\mu s$	$T_j = 25^\circ C$ TYP.	2 μs
I_L	$I_G = 1.2I_{GT}$	$T_j = 25^\circ C$ TYP.	50 mA
I_H	$I_T = 100mA$ Gate open	$T_j = 25^\circ C$ MAX.	30 mA
V_{TM}	$I_{TM} = 20A$ $t_p = 380\mu s$	$T_j = 25^\circ C$ MAX.	1.6 V
I_{DRM} I_{RRM}	V_{DRM} rated V_{RRM} rated	$T_j = 25^\circ C$ MAX.	0.01 mA
		$T_j = 110^\circ C$ MAX.	2 mA
dV/dt	Linear slope up to $V_D = 67\% V_{DRM}$ gate open	$T_j = 110^\circ C$ MIN.	200 V/ μs
tq	$V_D = 67\% V_{DRM}$ $I_{TM} = 20A$ $V_R = 25V$ $dI_{TM}/dt = 30 A/\mu s$ $dV_D/dt = 50V/\mu s$	$T_j = 110^\circ C$ TYP.	70 μs

Fig. 1: Maximum average power dissipation versus average on-state current.

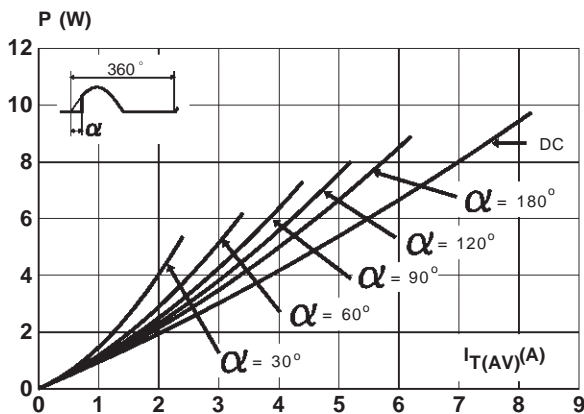

Fig. 2: Correlation between maximum average power dissipation and maximum allowable temperatures (T_{amb} and T_{case}) for different thermal resistances heatsink + contact.

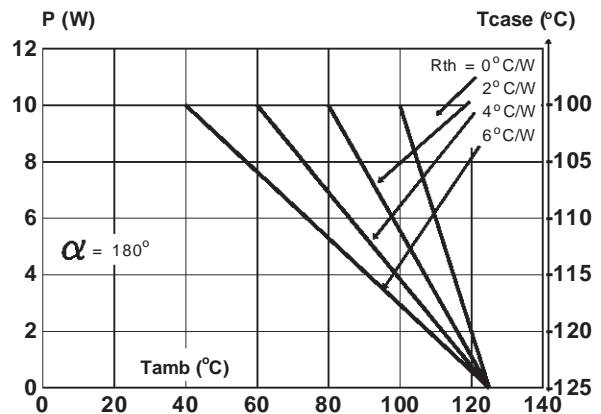

Fig. 3: Average on-state current versus case temperature.

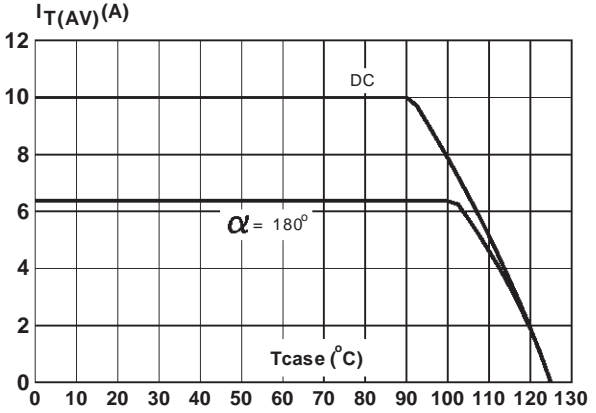

Fig. 4: Relative variation of thermal impedance versus pulse duration.

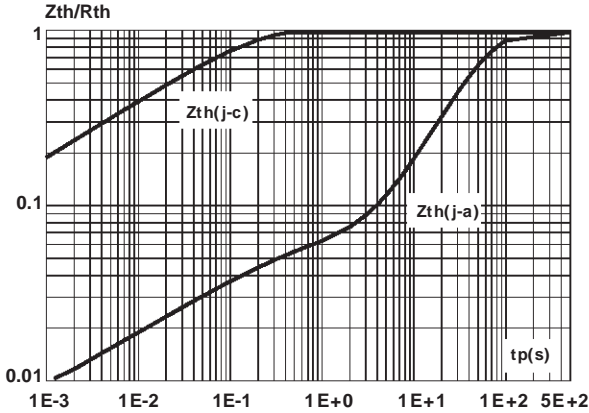

Fig. 5: Relative variation of gate trigger current versus junction temperature.

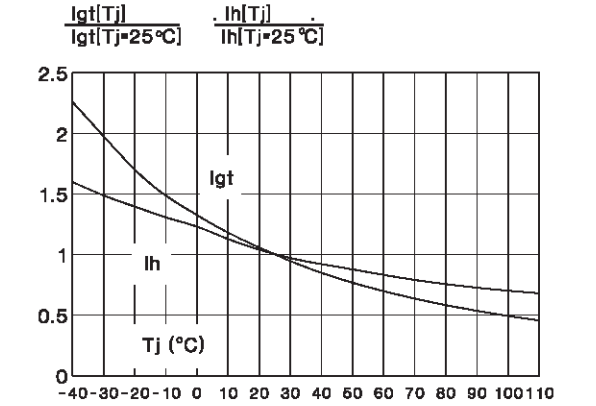

Fig. 6: Non repetitive surge peak on-state current versus number of cycles.

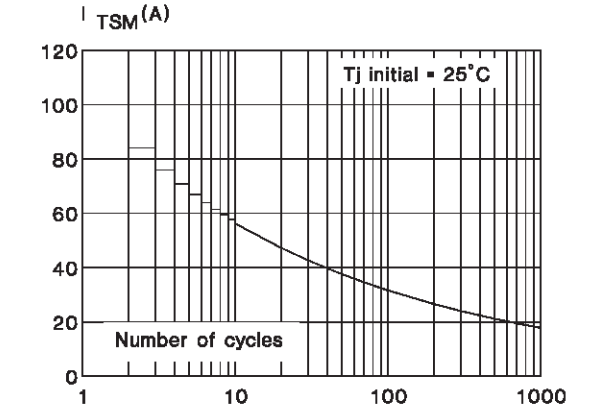

Fig. 7: Non repetitive surge peak on-state current for a sinusoidal pulse with width: $t \leq 10\text{ms}$, and corresponding value of I^2t .

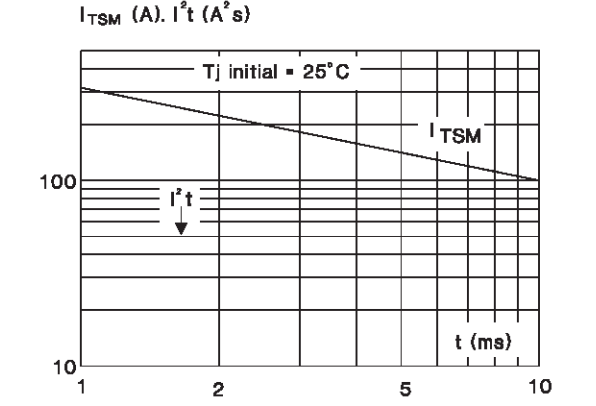
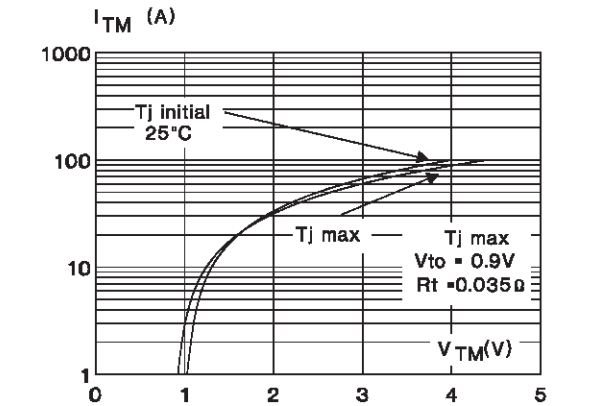
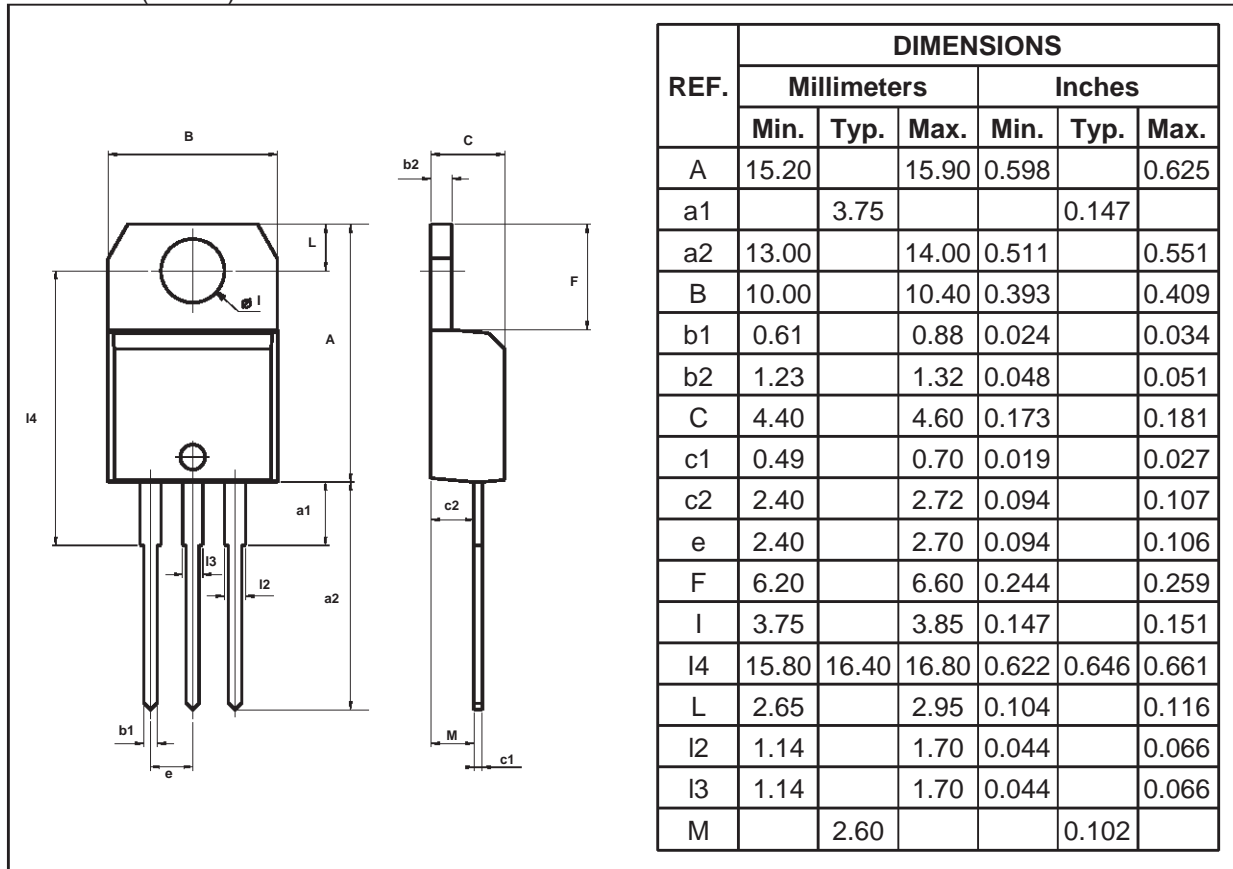

Fig. 8: On-state characteristics (maximum values).



PACKAGE MECHANICAL DATA
TO-220AB (Plastic)



OTHER INFORMATION

Ordering type	Marking	Package	Weight	Base qty	Delivery mode
TYNxx10	TYNxx10	TO-220AB	2.3 g	250	Bulk

- Epoxy meets UL94,V0
- Cooling method: C
- Recommended torque value: 0.8 m.N.
- Maximum torque value: 1 m.N.

Information furnished is believed to be accurate and reliable. However, STMicroelectronics assumes no responsibility for the consequences of use of such information nor for any infringement of patents or other rights of third parties which may result from its use. No license is granted by implication or otherwise under any patent or patent rights of STMicroelectronics. Specifications mentioned in this publication are subject to change without notice. This publication supersedes and replaces all information previously supplied. STMicroelectronics products are not authorized for use as critical components in life support devices or systems without express written approval of STMicroelectronics.

The ST logo is a registered trademark of STMicroelectronics

© 2001 STMicroelectronics - Printed in Italy - All rights reserved.

STMicroelectronics GROUP OF COMPANIES

Australia - Brazil - China - Finland - France - Germany - Hong Kong - India - Italy - Japan - Malaysia
Malta - Morocco - Singapore - Spain - Sweden - Switzerland - United Kingdom - U.S.A.

<http://www.st.com>