



■ Features :

- DC/DC step-down converter
- Constant current output: 300mA to 700mA
- Wide input voltage: 9 ~ 36VDC
- Wide output LED string voltage: 2 ~ 32VDC
- High efficiency up to 95%
- Built-in EMI filter, comply with EN55015 and FCC part15 without additional input filter and capacitors
- Built-in PWM dimming and remote ON/OFF control
- Protections: Short circuit / Over temperature
- Cooling by free air convection
- Fully encapsulated with IP67 level for pin and wire style
- Compact size
- Low cost, high reliability
- Suitable for driving illumination LED
- 3 years warranty



LDD-350L Blank : pin style
 W : wire style
 S : SMD style

SPECIFICATION

| ORDER NO. | | LDD-300L <input type="checkbox"/> | LDD-350L <input type="checkbox"/> | LDD-500L <input type="checkbox"/> | LDD-600L <input type="checkbox"/> | LDD-700L <input type="checkbox"/> | |
|--|---|--|-----------------------------------|-----------------------------------|-----------------------------------|-----------------------------------|-------|
| OUTPUT | CURRENT RANGE | 300mA | 350mA | 500mA | 600mA | 700mA | |
| | VOLTAGE RANGE <small>Note.4</small> | 2 ~ 32VDC for LDD-300~700L/LW ; 2~ 28VDC for LDD-300~700LS | | | | | |
| | CURRENT ACCURACY (Typ.) | ±5% at 24VDC input | | | | | |
| | RIPPLE & NOISE(max.) <small>Note.2</small> | 150mVp-p | 150mVp-p | 150mVp-p | 200mVp-p | 200mVp-p | |
| | SWITCHING FREQUENCY | 40KHz ~ 1000KHz | | | | | |
| | EXTERNAL CAPACITANCE LOAD (max.) | 2.2uF | | | | | |
| INPUT | VOLTAGE RANGE | 9 ~ 36VDC for LDD-300~700L/LW ; 9~ 32VDC for LDD-300~700LS | | | | | |
| | EFFICIENCY (max.) | 95% at full load and 24VDC/36VDC input for LDD-300~700L/LW ; 95% at full load and 24VDC input for LDD-300~700LS | | | | | |
| | DC CURRENT | Full load <small>Note.3</small> | 300mA | 350mA | 500mA | 600mA | 700mA |
| | | No load | 5mA | | | | |
| FILTER | Capacitor | | | | | | |
| PWM DIMMING & ON/OFF CONTROL | REMOTE ON/OFF | Leave open if not use | | | | | |
| | | Power ON with dimming: DIM ~ -Vin >3.5 ~ 8VDC or open circuit Power OFF : DIM ~ -Vin < 0.5VDC or short | | | | | |
| | PWM FREQUENCY | 100 ~ 1KHz | | | | | |
| QUIESCENT INPUT CURRENT IN SHUTDOWN MODE(max.) | 1mA at PWM dimming OFF and 24VDC input | | | | | | |
| PROTECTION | SHORT CIRCUIT | Regulated at rated output current Protection type: Can be continued, recovers automatically after fault condition is removed | | | | | |
| | OVER TEMPERATURE | Tj 150°C typically(IC1) detect on main control IC Protection type : Shut down, recovers automatically after temperature goes down | | | | | |
| ENVIRONMENT | WORKING TEMP. | -40 ~ + 85°C (Refer to derating curve) | | | | | |
| | WORKING HUMIDITY | 20% ~ 90% RH non-condensing for LDD-300~700L/LW ; 20% ~ 85% RH non-condensing for LDD-300~700LS | | | | | |
| | STORAGE TEMP., HUMIDITY | -55 ~ +125°C, 10 ~ 95% RH | | | | | |
| | TEMP. COEFFICIENT | ±0.03% / °C | | | | | |
| | VIBRATION | 10 ~ 500Hz, 2G 10min./1 cycle, period for 60min. each along X, Y, Z axes | | | | | |
| | OPERATING CASE TEMP. (max.) | 100°C | | | | | |
| EMC | EMC EMISSION | Compliance to EN55015, FCC part 15 class B | | | | | |
| | EMC IMMUNITY | Compliance to EN61000-4-2,3,4,6,8, light industry level, criteria A | | | | | |
| OTHERS | MTBF | 2000Khrs min. MIL-HDBK-217F (25°C) | | | | | |
| | DIMENSION | 22.6*9.9*8.9mm or 0.89**0.39**0.35" inch (L*W*H) for LDD-300~700L/LW ; 25.4*10.5*9.3mm or 1**0.4135**0.366" inch (L*W*H) for LDD-300~700LS | | | | | |
| | WEIGHT | LDD-300~700L:4g ; LDD-300~700LW:7.3g ; LDD-300~700LS :3.4g | | | | | |
| | POTTING MATERIAL | Expoxy(UL94-V0) for LDD-300~700L/LW ; without potted for LDD-300~700LS | | | | | |
| NOTE | 1.All parameters are specified at normal input(24VDC), rated load, 25°C 70% RH ambient. 2.Ripple & noise are measured at 20MHz by using a 12" twisted pair terminated with a 0.1uf capacitor. 3.Test condition: 24VDC input. 4.Output voltage will always step down by 3 volts from input DC voltage. 5.The output of LDD-L should not be connected to the input of the same unit or output from other sources. | | | | | | |

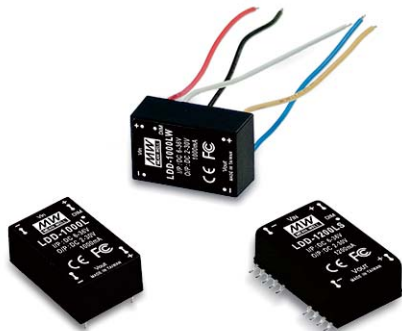

■ Features :

- DC/DC step-down converter
- Constant current output: 1000mA to 1500mA
- Wide input voltage: 6 ~ 36VDC
- Wide output LED string voltage: 2 ~ 30VDC
- High efficiency up to 95%
- Built-in EMI filter, comply with EN55015 and FCC part15 without additional input filter and capacitors
- Built-in PWM +analog dimming and remote ON/OFF control
- Protections: Short circuit
- Cooling by free air convection
- Fully encapsulated with IP67 level for pin and wire style
- Non-potted, optional conformal coating for SMD style (Order No.: LDD-1000LSC)
- Compact size
- Low cost, high reliability
- Suitable for driving illumination LED
- 3 years warranty



LDD-1000L W Blank : pin style
W : wire style
S : SMD style

SPECIFICATION

| ORDER NO. | LDD-1000L <input type="checkbox"/> | LDD-1200L <input type="checkbox"/> | LDD-1500L <input type="checkbox"/> | | |
|--|--|---|------------------------------------|---------|--------|
| OUTPUT | CURRENT RANGE | 1000mA | 1200mA | 1500mA | |
| | VOLTAGE RANGE <small>Note.4</small> | 2 ~ 30VDC | | | |
| | CURRENT ACCURACY (Typ.) | ±5% at 24VDC input | | | |
| | RIPPLE & NOISE(max.) <small>Note.2</small> | 1.5Vp-p | 1.5Vp-p | 1.5Vp-p | |
| | SWITCHING FREQUENCY | 1000KHz | | | |
| EXTERNAL CAPACITANCE LOAD (max.) | 2.2uF | | | | |
| INPUT | VOLTAGE RANGE | 6 ~ 36VDC | | | |
| | EFFICIENCY (max.) | 95% at full load and 24VDC/36VDC input for LDD-1000~1500L/LW | | | |
| | DC CURRENT | Full load <small>Note.3</small> | 990mA | 1160mA | 1450mA |
| | | No load | 5mA | | |
| FILTER | Capacitor | | | | |
| PWM DIMMING & ON/OFF CONTROL | REMOTE ON/OFF | Leave open if not use | | | |
| | | Power ON with dimming: DIM ~ -Vin >2.6 ~ 5.5VDC or open circuit | | | |
| | | Power OFF : DIM ~ -Vin < 0.4VDC or short | | | |
| PWM FREQUENCY | 100 ~ 500Hz | | | | |
| QUIESCENT INPUT CURRENT IN SHUTDOWN MODE(max.) | 1mA at PWM dimming OFF and 24VDC input | | | | |
| ANALOG DIMMING & ON/OFF CONTROL | REMOTE ON / OFF | Leave open if not use | | | |
| | | Power ON with dimming : DIM ~ -Vin>0.5~2.5VDC or open circuit | | | |
| | | Power OFF : DIM ~ -Vin<0.4VDC or short | | | |
| PROTECTION | SHORT CIRCUIT | Regulated at rated output current | | | |
| | | Protection type: Can be continued, recovers automatically after fault condition is removed | | | |
| ENVIRONMENT | WORKING TEMP. | -40 ~ + 71°C (Refer to derating curve) | | | |
| | WORKING HUMIDITY | 20% ~ 90% RH non-condensing for LDD-1000~1500L/LW ; 20%~85% RH non-condensing for LDD-1000~1500LS | | | |
| | STORAGE TEMP., HUMIDITY | -55 ~ +125°C, 10 ~ 95% RH | | | |
| | TEMP. COEFFICIENT | ±0.03% / °C | | | |
| | VIBRATION | 10 ~ 500Hz, 2G 10min./1 cycle, period for 60min. each along X, Y, Z axes | | | |
| OPERATING CASE TEMP. (max.) | 100°C | | | | |
| EMC | EMC EMISSION | Compliance to EN55015, FCC part 15 class B | | | |
| | EMC IMMUNITY | Compliance to EN61000-4-2,3,4,6,8, light industry level, criteria A | | | |
| OTHERS | MTBF | 2000Khrs min. MIL-HDBK-217F (25°C) | | | |
| | DIMENSION | 31.8*20.3*12.2mm or 1.25**0.8**0.48" inch (L*W*H) for LDD-1000~1500L/LW ; 31.8*20.3*10.9mm or 1.25**0.8**0.43" inch (L*W*H) for LDD-1000~1500LS | | | |
| | WEIGHT | LDD-1000~1500L:15.6g ; LDD-1000~1500LW:18g ; LDD-1000~1500LS:12.8g | | | |
| | POTTING MATERIAL | Expoxy(UL94-V0) for LDD-1000~1500L/LW ; without potted for LDD-1000~1500LS | | | |
| NOTE | 1. All parameters are specified at normal input(24VDC), rated load, 25°C 70% RH ambient. 2. Ripple & noise are measured at 20MHz by using a 12" twisted pair terminated with a 0.1uf capacitor. 3. Test condition: 36VDC input. 4. Output voltage will always step down by 3 volts from input DC voltage. 5. The output of LDD-L should not be connected to the input of the same unit or output from other sources. | | | | |

■ Mechanical Specification

Blank type(LDD-300~700L):

Unit: mm (inch)

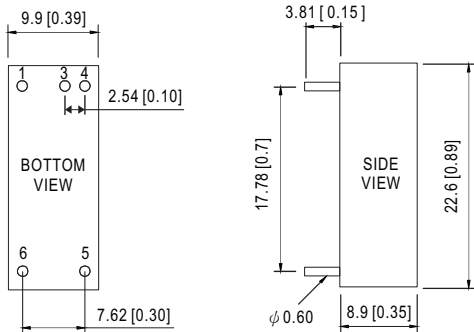

NOTE: Pin tolerance $\pm 0.05\text{mm}$

W type(LDD-300~700LW):

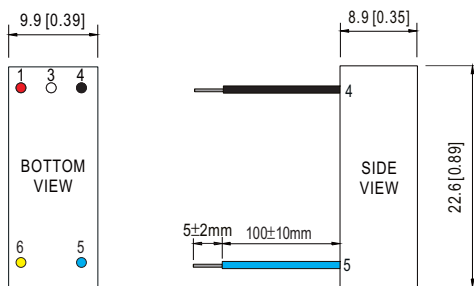

NOTE: All wires UL3385 22AWG

S type(LDD-300~700LS):

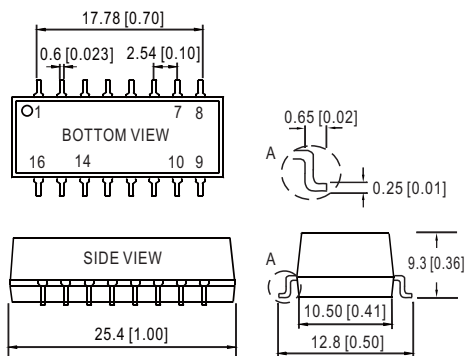

■ Recommended PCB layout (for LDD-300~700LS)

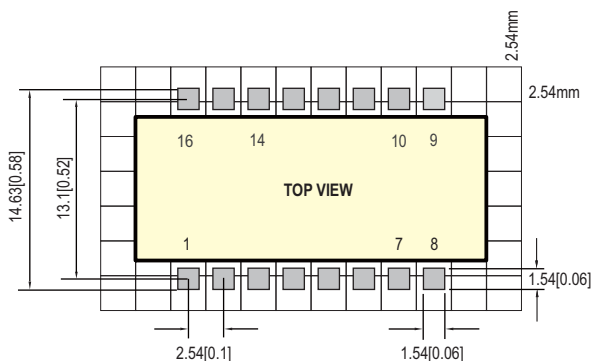

■ Pin Configuration

| Pin No. | Output | Comment |
|---------|---------|---|
| 1 | +Vin | DC Supply |
| 3 | PWM DIM | ON/OFF and PWM Dimming (Leave open if not used) |
| 4 | -Vin | Don't connect to -Vout |
| 5 | -Vout | LED - Connection |
| 6 | +Vout | LED + Connection |

| Pin No. | Output | Comment |
|---------|-----------------|---|
| 1 | +Vin (Red) | DC Supply |
| 3 | PWM DIM (White) | ON/OFF and PWM Dimming (Leave open if not used) |
| 4 | -Vin (Black) | Don't connect to -Vout |
| 5 | -Vout (Blue) | LED - Connection |
| 6 | +Vout (Yellow) | LED + Connection |

| Pin No. | Output | Comment |
|---------|---------|---|
| 1 | +Vin | DC Supply |
| 7,8 | +Vout | LED + Connection |
| 9,10 | -Vout | LED - Connection |
| 14 | PWM DIM | ON/OFF and PWM Dimming (Leave open if not used) |
| 16 | -Vin | Don't connect to -Vout |
| others | N.C | LED - Connection |

Mechanical Specification

Blank type(LDD – 1000~1500L):

Unit: mm (inch)

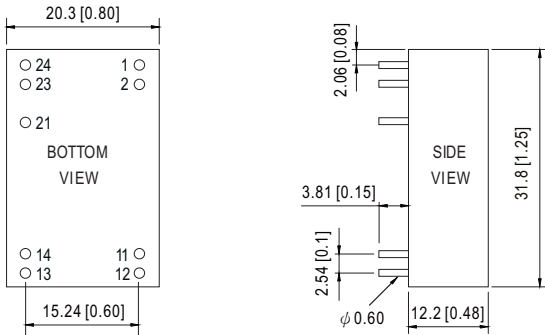

NOTE: Pin tolerance ± 0.05 mm

W type(LDD – 1000~1500LW):

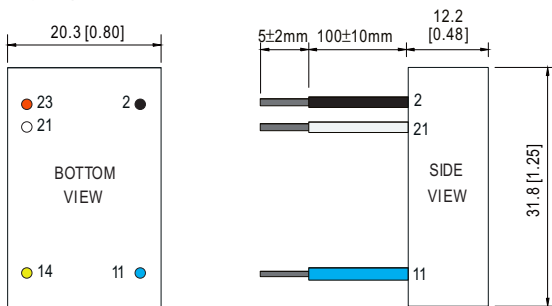

NOTE: All wires UL3385 22AWG

S type(LDD – 1000~1500LS):

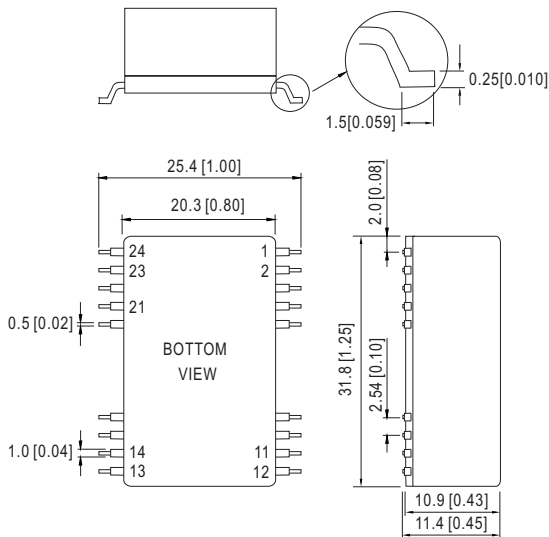

Recommended PCB layout (for LDD-1000~1500LS)

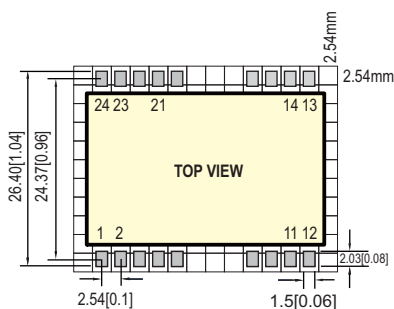

Pin Configuration

| Pin No. | Output | Comment |
|---------|-----------------|--|
| 1,2 | -Vin | Don't connect to -Vout |
| 11,12 | -Vout | LED - Connection |
| 13,14 | +Vout | LED + Connection |
| 21 | PWM +analog DIM | ON/OFF and PWM / analog Dimming (Leave open if not used) |
| 23,24 | +Vin | DC Supply |

| Pin No. | Output | Comment |
|---------|-------------------------|--|
| 2 | -Vin (Black) | Don't connect to -Vout |
| 11 | -Vout (Blue) | LED - Connection |
| 14 | +Vout (Yellow) | LED + Connection |
| 21 | PWM +analog DIM (White) | ON/OFF and PWM / analog Dimming (Leave open if not used) |
| 23 | +Vin (Red) | DC Supply |

| Pin No. | Output | Comment |
|---------|-----------------|--|
| 1,2 | -Vin | Don't connect to -Vout |
| 11,12 | -Vout | LED - Connection |
| 13,14 | +Vout | LED + Connection |
| 21 | PWM +analog DIM | ON/OFF and PWM / analog Dimming (Leave open if not used) |
| 23,24 | +Vin | DC Supply |
| others | N.C | No connection |

■ Reflow Soldering Curve (for LDD-300~1500LS)

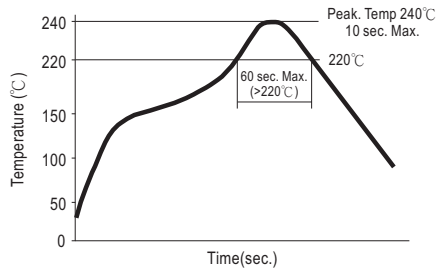

Remark : The curve applies only to the " Hot Air Reflow Soldering"

■ Derating Curve

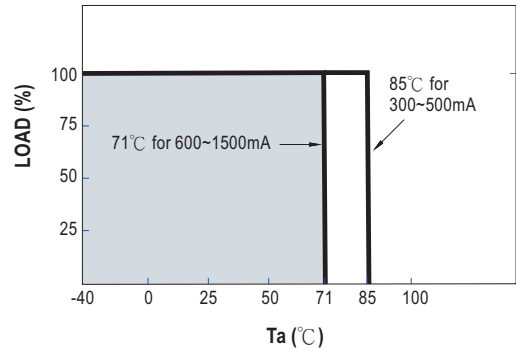

■ PWM Dimming Control (for 300~1500mA)

To Adjustment by PWM signal :

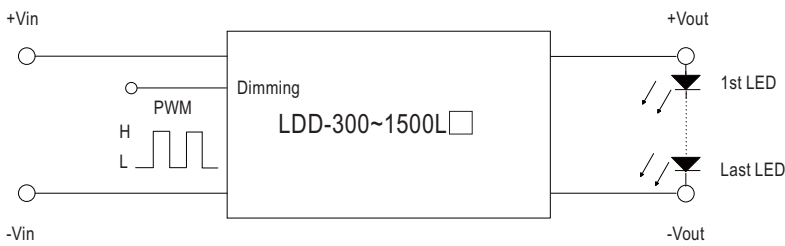

300 ~ 700mA :

- H: > 3.5~8VDC or open circuit
- L: < 0.5VDC or short

1000 ~ 1500mA :

- H: > 2.6~5.5VDC or open circuit
- L: < 0.4VDC or short

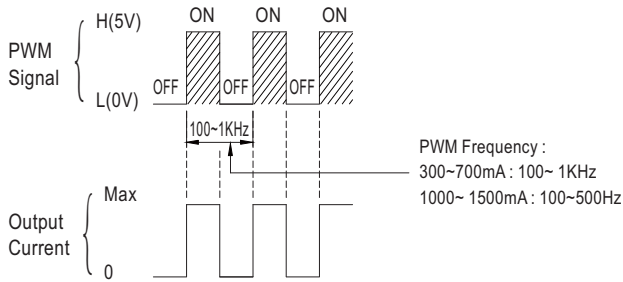

© During PWM dimming operation, the output current will change to PWM style.

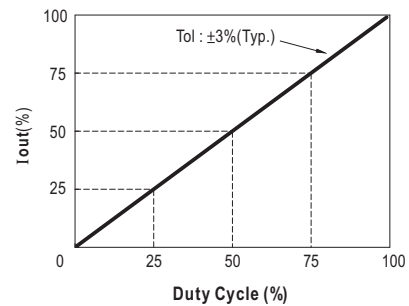

■ Analog Dimming Control for 1000~1500mA only

To Adjustment by DC voltage :

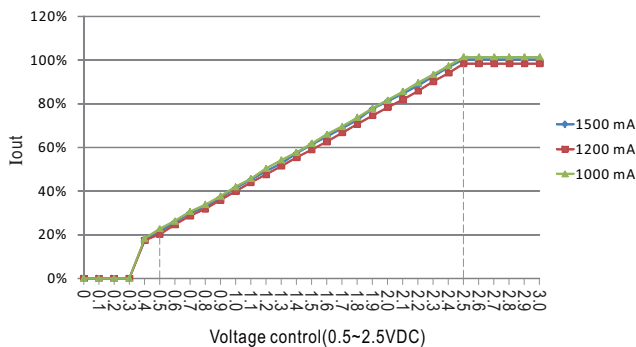
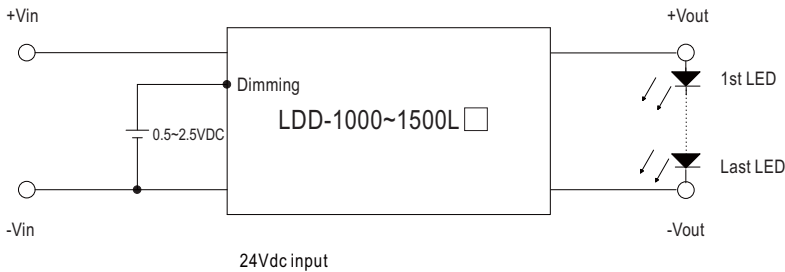

■ Efficiency VS Output Voltage(Number of LEDs)

Fig-1 12VDC input, 1~3 LEDs(Vf=3V)

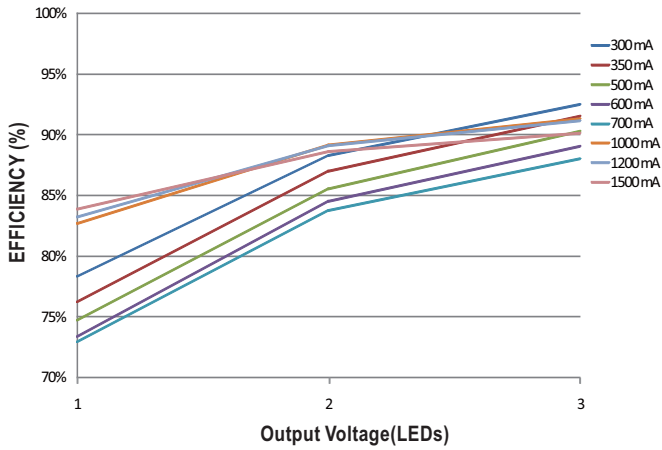

Fig-2 24VDC input, 1~7 LEDs(Vf=3V)

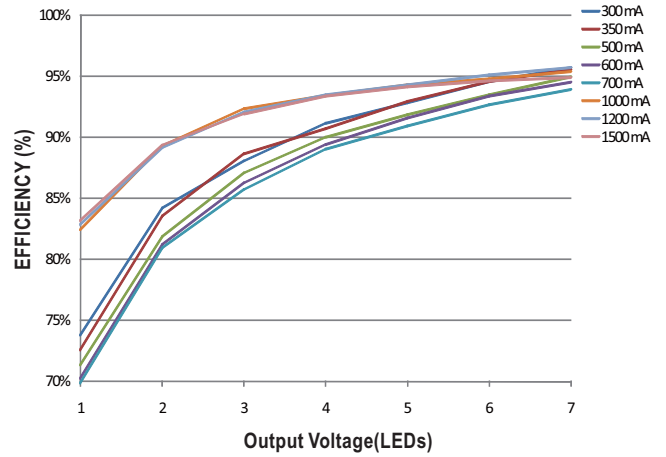

Fig-3 36VDC input, 1~10 LEDs(Vf=3V)

